









































Light Bulbs + Sockets

Prices see **Main Assortment**
shop.griederbauteile.ch

Prices see **Treasure Trove**
shop.griederbauteile.ch

E10 Multi LED	Page 2 - 3 Page 3				
E5/8 + E5.5/16 E14	Page 4				
E27 + E40 (Projection Lamps) T2 Ba7s	Page 5				
Ba9s Ba15s + Ba15d	Page 6 + 7 Page 7				
Ba20s + Ba20d	Page 8				
T³/₄ T1	Page 8 + 9				
T¹/₄ + T1¹/₂ + T1³/₄ Special Bulbs + Wedge Base	Page 9 - 13 Page 14				
LED Lamps + Projection Lamps Halogen + Fluorescent	Page 15 Page 16				
Festoon Telecommunication Bulbs	Page 17 Page 17 - 20				
Glow Lamps Indicator Lights	Page 20 Page 21				
Sockets	Page 21 - 23				

Light Bulbs E10 Spherical Shape

Order No	Voltage	Current	Power	Bailey Number
EBA.0110	1.5V	100mA	150mW	E24001090
EBA.0210	2.5V	100mA	250mW	E24001100
EBA.0230	2.5V	300mA	750mW	E24002300
EBA.0407	3.8V	80mA	266mW	E24003070
EBA.0430	3.8V	300mA	1140mW	E24003301
EBA.0605	6V	50mA	300mW	E24006050
EBA.0610	6V	100mA	600mW	E24006100
EBA.0630	6V	300mA	1800mW	E24006300
EBA.1205	12V	50mA	600mW	E24012050
EBA.1210	12V	100mA	1200mW	E24012100
EBA.1225	12V	250mA	3W	E24012250
EBA.2402	24V	20mA	480mW	
EBA.2405	24V	50mA	1200mW	E24024050
EBA.2412	24V	125mA	3W	E24024125
EBA.3602	36V	20mA	720mW	
EBA.3605	36V	50mA	1800mW	E24036050
EBA.3608	36V	83mA	3W	
EBA.4802	48V	20mA	960mW	
EBA.4804	48V	40mA	1920mW	
EBA.4806	48V	63mA	3W	
EBA.6002	60V	20mA	1200mW	
EBA.6004	60V	40mA	2400mW	

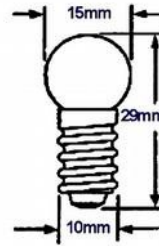

Light Bulbs E10 Cylindrical Shape

Order No	Voltage	Current	Power	Bailey Number
EBB.0230	2.5V	300mA	850mW	E28002300
EBB.0406	4V	60mA	240mW	
EBB.0410	4V	100mA	400mW	E28004100
EBB.0430	4V	300mA	1.2W	E28004300
EBB.H0450	4V Halogen	500mA		Osram 6405730
	4V	40mA		
EBB.0460	4V	600mA	2.4W	E28004600
13.45150	4.5V	150mA		
EBB.0602	6V	20mA	120mW	
EBB.0603	6V	30mA	180mW	
EBB.0605	6V	50mA	300mW	E28006050
EBB.0610	6V	100mA	600mW	E28006100
13.06180	6V	180mA		
EBB.0630	6V	300mA	1.8W	E28006300
EBB.0650	6V	500mA	3W	E28006500
EBB.0683	6V	830mA	5W	E28006830
EBB.0710	7V	100mA	700mW	E28007100
EBB.0730	7V	300mA	2.1W	E28007300
EBB.1202	12V	20mA	240mW	E28012020
EBB.1205	12V	50mA	600mW	E28012050
EBB.1210	12V	100mA	1.2W	E28012100
EBB.1217	12V	170mA	2.04W	Osram 3453
EBB.1225	12V	250mA	3W	E28012250
13.12950	12V		5W	
13.19120	19V	120mA		
EBB.2402	24V	20mA	480mW	
EBB.2405	24V	50mA	1.2W	E28024050
EBB.2408	24V	80mA	1.92W	E28024080
13.24080	24V	80mA		
EBB.2412	24V	125mA	3W	E28024125
13.24030	24V		3W	
EBB.2805	28V	50mA	1.4W	E28028050
EBB.2810	28V	107mA	3W	E28028100
EBB.3602	36V	20mA	720mW	
EBB.3605	36V	50mA	1.8W	E28036050
EBB.3608	36V	83mA	3W	
EBB.4802	48V	20mA	960mW	E28048020
EBB.4804	48V	40mA	1.92W	E28048040
EBB.4806	48V	63mA	3W	E28048060
EBB.6002	60V	20mA	1.2W	E28060020
EBB.6004	60V	40mA	2.4W	E28060040
EBB.6008	60V		5W	

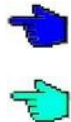

Light Bulbs (Torch Bulbs) E10 Spherical Shape

Order No	Voltage	Current	Power	Dimensions
05.25301	2.5V	300mA		11 x 28mm
05.38300	3.8V	300mA		
05.38301	3.8V	300mA		
06.06930	6V		3W	15 x 27mm



Intermittent Light Bulbs E10 Spherical

Order No	Voltage	Current	Power	Dimensions
EBD.02	2.5V	300mA	750mW	15 x 29mm
EBD.03	3.5V	300mA	1050mW	
EBD.06	6V	500mA	3W	

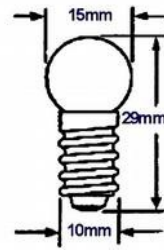

Intermittent Light Bulbs E10 Cylindrical

Order No	Voltage	Current	Power	Dimensions
EBF.02	2.5V	300mA	750mW	10 x 28mm
EBF.03	3.5V	300mA	1050mW	
EBF.05	5.3V	500mA	2650mW	

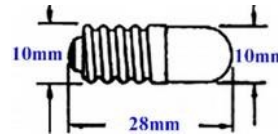

Lenticular Light Bulbs 6/9 Bantam E10

Order No	Voltage	Current	Power	Bailey Number
EBC.0122	1.2V	220mA	264mW	EL0120220
07.22180	2.2V	180mA		Philips 7067D
EBC.0220	2.5V	200mA	2500mW	EL0250200
EBC.0230	2.5V	300mA	750mW	EL0250300
EBC.0430	3.7V	300mA	1110mW	EL0370300



Misc Light Bulbs with E10 Socket

Order No	Voltage	Current	Dimensions	Description
20.37300	3.7V	300mA	9.5x24mm	Osram 3644
	5.2V	850mA	9.3x31mm	Halogen
86.06960	6V	1A/6W	15x28mm	Automotive bulb
	6V	20mA	9.7x24.7mm	8mm LED light bulb
12.60020	60V	20mA	8.5x23mm	Signal lamp
EBA.3403K	34V	3W	13.5x45mm	Candle shape



Neon Glow Lamps E10 Cylindrical 10x28mm

Order No	Voltage	Description
EBB.G110	110V	T3-¼, 10x28mm, with built-in dropping resistor
EBB.G220	220V	
EBB.G380	380V	



Glow Lamps E10 Cylindrical Shape

Order No	Voltage	Description	Dimensions
70.12110	110V	Neon	10 x 25mm
70.13139	110-130V	Neon	10 x 28mm
70.13226	220V	Yellow coloured glass	
70.13227	220V	Red coloured glass	
70.13229	220V	Signal colour green	
70.13223	220V	Blue	
70.13222	220V	Red (fluorescent)	
70.13224	220V	Signal colour w hite	
	380V	Red (fluorescent)	

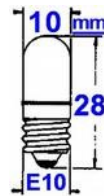

Multi LED with E10/14 Socket

Order No	Voltage	Description	Dimensions
85.8824A	24V	With 8 yellow LED	11 x 20mm
85.8824G		With 8 green LED	
85.8724G		With 8 green LED	
85.8824R		With 8 red LED	



Multi LED with E12/15 Socket

Order No	Voltage	Description	Type
	24V	With 8 yellow LED	LD0807A24A
		With 8 yellow LED	LD0807D24A
85.9024G		With 8 green LED	LD0807D24A
85.9024M		With 8 mixed LED	LD0807D24M
85.9024R		With 8 red LED	LD0807D24R

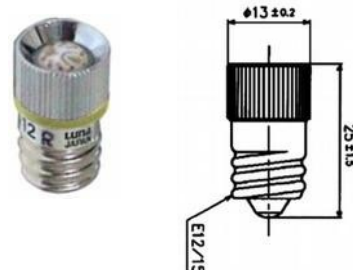

Miniature Light Bulbs E5/8 + E5.5/16

Order No	Voltage	Current	Socket
44.25250	2.5V	250mA	E5/8 LES
44.25300	2.5V	300mA	E5/8 LES
44.25400	2.5V	400mA	E5/8 LES
	3V	15mA	E5/8 LES
44.03200	3.5V	200mA	E5/8 LES
	4.5V	200mA	E5/8 LES
44.06020	6V	20mA	E5.5/16 (6x21mm)
	6V	100mA	E5/8 LES
44.12060	12V	60mA	E5/8 LES
44.12120	12V	120mA	E5.5/16 (6x21mm)
44.14000	14V	??	E5/8 LES
44.14040	14V	40mA	E5/8 LES
44.24050	24V	50mA	E5.5/16 (6x21mm)
44.24060	24V	60mA	E5/8 LES

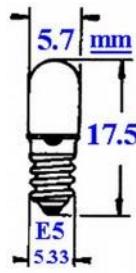

E5/8 LES



E5.5/16



Incandescent Bulbs with E14 Socket

Order No	Voltage	Power	Measure	Description
	6V	180mA	13x30mm	
	6V	4.5A	35x67mm	Spherical Shape
	6V	5W	16x54mm	
	12V	5W	16x54mm	
	24V	5W	16x54mm	
	24V	10W	26x54mm	Tapered Shape
	24V	25W	20x85mm	
	36V	5W	16x35mm	
	48V	3W	13x30mm	
	60V	5W	16x54mm	
	60V	40W		Kerzenform
	110-120V	25W	26x54mm	
	150V	10W	26x52mm	Tapered Shape
	220-260V	5-7W	16x35mm	
	220-260V	5-7W	16x48mm	
	220-260V	7-10W	16x48mm	
	220-260V	7-10W	26x52mm	Tapered Shape
	220-260V	7-10W	22x48mm	Tapered Shape
	220-260V	10W	22x60mm	
	220-260V	10-15W	22x48mm	Konische Form
	220-260V	15W	26x60mm	Konische Form
89.22015	220V	15W	22x50mm	Backofen 300°C
	220-240V	20W	25x70mm	
83.22921	220-240V	20W	25x70mm	Backofen 300°C
	220V	25W	25x70mm	
	220-230V	25W	25x62mm	
89.22025	240V	25W	25x56mm	Backofen 300°C
89.22940	220-230V	40W	45x75mm	Backofen 300°C
	220-250V	40W	25x68mm	
	220-230V	40W		Concentra R50



16x48mm



83.22060



83.22910



16x54mm



78.260007



83.26xxx



26x54mm



Oven Light Bulb

Glow Lamps with E14 Socket

Order No	Voltage	Dimensions	Description
70.76226	220V	13x30mm	Yellow
70.76221		14x30mm	Fluorescent green
70.79222		16x54mm	Fluorescent red



Incandescent Bulbs with E27 Socket

Order No	Voltage	Power	Dimensions	Description
83.12915	12V	15W	40x64mm	Klar
81.24940	24V	40W	60x105mm	Matt
	220V	15W	35x55mm	Klar
83.12215	220V	15W	35x55mm	Matt
	220V	25W	35x55mm	Klar
	220V	25W	35x55mm	Matt
82.20960	220-230V	60W	Spotlight	Osram Concentra R63
	220-230V	100W	47x115mm	Halogen lamp
	220V	175W	122x133mm	Philips IR175R-PAR38
	220V	250W	32x105mm	Halogen lamp



83.12xxx 82.20960 87.22xxx

LED Lamps with E27 Socket

Order No	Voltage	Power	Dimensions
LED.8WW.E27B	230VAC	7.5W	60x120mm
LED.13WW.E27B	230VAC	12.8W	60x123mm



Projection Lamp with E40 Socket

Order No	Voltage	Power	Dimensions
89.22500	220-250V	500W	40x210mm



T2 Light Bulbs Ba7s Socket (Midget Bayonet 7x20mm)

Order No	Voltage	Current	Power
	2.5V	250mA	625mW
	4V	250mA	1W
	6V	50mA	300mW
	6V	100mA	600mW
	6V	200mA	1.2W
	7V	100mA	700mW
	12V	20mA	240mW
	12V	50mA	600mW
	12V	100mA	1.2W
	14V	100mA	1.4W
	24V	25mA	600mW
	24V	50mA	1.2W
ECB.2802	28V	25mA	700mW
ECB.2805	28V	50mA	1.4W
ECB.3602	36V	20mA	720mW
ECB.4802	48V	20mA	960mW
ECB.6002	60V	20mA	1.2W

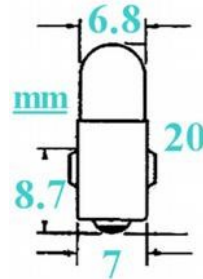

T2 Glow Lamps Ba7s Socket (Midget Bayonet 7x20mm)

Order No	Voltage	Current	Dimensions	Description
ECB.G220	230V		7x22mm	Drop shape
62.48050	48V	50mA	7x23mm	Tubular shape
62.60020	60V	20mA	7x23mm	Tubular shape

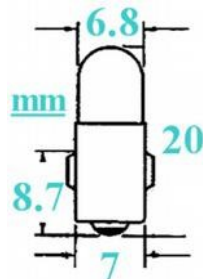

Light Bulbs Ba9s Socket (Miniature Bayonet T3-1¼)

Order No	Voltage	Current	Power	Dimensions	Description
09.06070	6V	70mA		8.5x23mm	
10.06200	6V	200mA		10x28mm	
09.12050	12V	50mA		8.5x23mm	
ECA.H1242	12V		5W	9.3x33mm	Halogen
09.14080	14V	80mA		8.5x23mm	
09.24025	24V	25mA		8.5x23mm	
09.24050	24V	50mA	1.2W	8.5x23mm	
09.24080	24V	80mA		8.5x23mm	
09.24920	24V		2W	8.5x23mm	Vehicle light bulb
09.24930	24V		3W	8.5x23mm	Vehicle light bulb
09.28920	28V		2W	8.5x23mm	
09.30050	30V	50mA	1.5W	8.5x23mm	
09.30920	30V		2W	8.5x23mm	
09.30930	30V		3W	8.5x23mm	
09.13020	130V			8.5x23mm	
09.22093	220V		3W	8.5x23mm	



LED Lamps Ba9s (Miniature Bayonet Ba9s Socket)

Order No	Volt AC/DC	Current	Dimensions	Type	Description
85.8124A	24V		10x25mm	LD803A24A	8 yellow LED
85.8224A	24V		10x25mm	LD803D24A	8 yellow LED
85.8248A	48V		10x25mm	LD803D48A	8 yellow LED
85.8224G	24V		10x25mm	LD803D24G	8 green LED
85.8324A	24V		11x20mm	LD804A24A	8 yellow LED
85.8124G	24V		10x25mm	LD803A24G	8 green LED
ELF.2420	24V	20mA	10x25mm	W7B90	
85.8248G	48V		10x25mm	LD803D48G	8 green LED
85.8424G	24V		11x20mm	LD804D24G	8 green LED
85.8224M	24V		10x25mm	LD803D24M	8 mixed colours
85.8224R	24V		10x25mm	LD803D24R	8 red LED
85.8248R	48V		10x25mm	LD803D48R	8 red LED



ELF.2420



Glow Lamps Ba9s (Miniature Bayonet Ba9s Socket)

Order No	Voltage	Size	Description
ECA.G110	110V	10x28mm	With built-in pre-resistor
70.09110	110V	10x25mm	Neon
70.10116	110V	10x28mm	Neon
70.10112	110V	10x28mm	Fluorescent red
ECA.G220	220V	10x28mm	With built-in pre-resistor
70.10225	220V	10x28mm	Fluorescent yellow
ECA.G220G	220V	10x28mm	For green lenses
70.10229	220V	10x28mm	Fluorescent green
70.10222	220V	10x28mm	Fluorescent rot
70.10224	220V	10x28mm	Fluorescent w hite
70.10226	220V	10x28mm	Glass yellow colour
ECA.G380	380V	10x28mm	With built-in pre-resistor
70.09380	380V	10x25mm	Neon

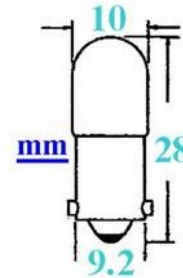

Light Bulb Ba15d Socket (Double Contact Bayonet Ba15d)

Order No	Voltage	Power	Dimensions	Description
	6V	15W	16x52mm	Vehicle light bulb
86.06915	6V	15W	18x53mm	Vehicle light bulb
74.12950	12V	5W	16x54mm	
72.12911	12V	10W	18x37mm	Spherical shape
83.12912	12V	12W	35x60mm	Spherical shape
89.12593	12.5V	3A	35x58mm	Mirrored (M)
89.24925	24V	25W	39x63mm	Dr G Fischer Vehicle light (M)
89.24940	24V	40W	39x63mm	Dr G Fischer Vehicle light (M)
74.36910	36V	10W	26x54mm	
74.60950	60V	5W	16x54mm	
75.80950	80V	5W	16x48mm	
74.13047	110V-140V	4-7W	22x43mm	
75.13071	110V-140V	7-10W	16x48mm	
63896	110V	15W	22x57mm	
89.11530	115V	30W	40x60mm	Mirrored (M)



Mirrored



Ba15d



Glow Lamps Ba15d Socket (Double Contact Bayonet Ba15d)

Order No	Voltage	Size	Description
70.74221	220V	16x52mm	Fluorescent yellow
70.74222	220V	16x52mm	Fluorescent red
70.74220	220V	16x52mm	Neon
	380V	14x30mm	Neon



Ba15d

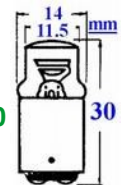

70.72380



Light Bulbs Ba15s Socket (Single Contact Bayonet Ba15s)

Order No	Voltage	Power	Size	Description
86.06910	6V	10W	13x34mm	Vehicle light bulb
72.06910S	6V	10W	18x35mm	Hama 3569
83.06910	6V	10W	25x42mm	
	6.2V	40W	39x61mm	Mirrored (M)
73.07063	7V	630mA	18x35mm	Juke Box Bulb
86.12919	12V	18W	25x48mm	Vehicle light bulb
86.12921	12V	21W	26x52mm	Vehicle bulb OSRAM 7506 P21W
83.12903	12.6V	3A	35x60mm	
73.13059	13.5V	590mA	18x35mm	Pin Ball Bulb
75.28921	28V	21W	16x52mm	Tapered
89.28926	28V	26W	32x51mm	Mirrored (M)
	28V	40W	39x61mm	Mirrored (M) 7079A
	28V	40W	32x61mm	Mirrored (M)



Ba15s



Mirrored



Light Bulbs Ba20d (Double Contact Bayonet Ba20d)

Order No	Voltage	Power	Dimensions	Description
89.69500	6V	5A	35x60mm	Colposcop OSRAM 8025
83.24940	24V	40W	45x70mm	
	24V	50W	42x67mm	Mirrored (M)



Light Bulbs Ba20s (Single Contact Bayonet Ba20s)

Order No	Voltage	Power	Dimensions	Description
	6V	35W	35x60mm	Vehicle lamp
	12V	35W	35x60mm	Vehicle lamp OSRAM 7309



T 3/4 Light Bulb MM3s6 Socket (MMF Micro Midget Flange)

Order No	Voltage	Current	Power	Schurter No
EBX.0104	1V	40mA	40mW	0913.0001
EBX.0205	2V	50mA	100mW	0913.0002
	4V	50mA	200mW	0913.0004
	5V	21mA		
EBX.0605	6V	50mA	300mW	0913.0006
EBX.1205	12V	50mA	600mW	0913.0012
26.14030	14V	30mA		
EBX.1603	16V	30mA	480mW	0913.0016
EBX.2402	24V	20mA	480mW	0913.0024
26.24040	24V	40mA		
26.28020	28V	20mA		

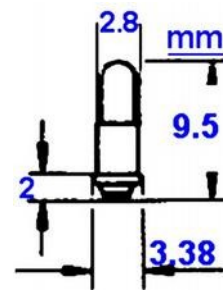

ESY.x
Suitable lamp holders for light bulbs with T^{3/4} MMF sockets
See page 23

T 3/4 Light Bulbs WT (Wire Terminal)

Order No	Voltage	Current	Power	Number
EAW.0101	1.5V	15mA	23mW	
EAW.0502	5V	20mA	100mW	
EAW.0506	5V	60mA	300mW	
24.05075	5V	75mA		7133 USA
EAW.0511	5V	115mA	575mW	
24.24016	24V	16mA		
24.28040	28V	40mA		

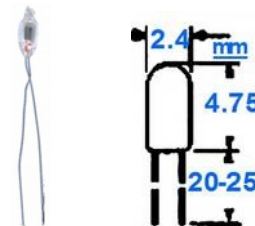

T 1 Light Bulbs SX4s Socket (SMF Sub Midget Flange)

Order No	Voltage	Current	Number
30.05020	5V	30mA	
30.05061	5V	60mA	685 USA
30.05115	5V	115mA	718 USA
30.06070	6V	70mA	
30.06200	6V	200mA	
30.10027	10V	27mA	7240 USA
30.12030	12V	30mA	
30.14065	14V	65mA	8112 USA
30.18026	18V	26mA	7241 USA
30.24020	24V	20mA	
30.28024	28V	24mA	6839 USA
30.28040	28V	40mA	
30.36020	36V	20mA	

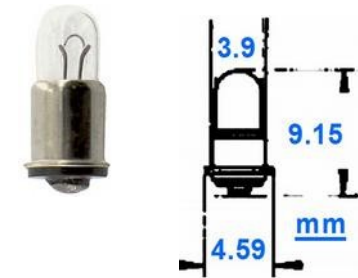

T 1 Light Bulbs WT (Wire Terminal)

Order No	Voltage	Current	Power	Number
29.03015	3V	15mA		Bailey WE03030151
EAX.0502	5V	20mA	100mW	862WL USA
29.05030	5V	30mA		Bailey WE03050301
EAX.0506	5V	60mA	300mW	Bailey WE03050601
29.05075	5V	75mA		Bailey WE03050751
EAX.0511	5V	115mA	575mW	Bailey WE03051151
EAX.1002	10V	27mA	270mW	Bailey WE03100271
EAX.1203	12V	30mA	360mW	Bailey WE03120301
EAX.1206	12V	60mA	720mW	Bailey WE03120601
EAX.1404	14V	40mA	560mW	Bailey WE03140401
EAX.1406	14V	65mA	910mW	Bailey WE03140651
EAX.1802	18V	26mA	468mW	Bailey WE03180261
EAX.2402	24V	20mA	480mW	Bailey WE03240201
EAX.2802	28V	24mA	575mW	Bailey WE03280241
29.28040	28V	40mA		Bailey WE03280401
29.750NE	75VAC	200mA	Neon	

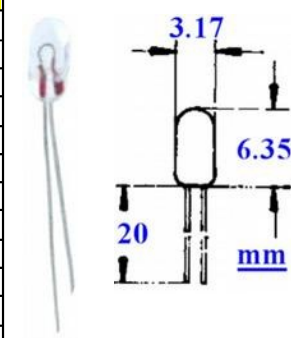

T1 Light Bulbs BP Bi-Pin 1.27mm Pitch			
Order No	Voltage	Current	Number
32.05061	5V	60mA	Bailey BP13050601
32.05075	5V	75mA	Bailey BP13050751
32.05115	5V	115mA	Bailey BP13051151
32.10027	10V	27mA	8095 BP
32.12030	12V	30mA	Bailey BP13120301
32.12060	12V	60mA	Bailey BP13120601
32.18026	18V	26mA	8099 BP
32.24020	24V	20mA	
32.28024	28V	24mA	Bailey BP13280241
32.36020	36V	20mA	

T1 Light Bulbs BP Bi-Pin 2.54mm Pitch			
Order No	Voltage	Current	Number
33.05020	5V	20mA	
33.05060	5V	60mA	Bailey BP23050601
EBP.0611	6V	115mA	Bailey BP23061151
33.12030	12V	30mA	
EBP.1206	12V	60mA	Bailey BP23120601
EBP.1802	18V	26mA	Bailey BP23180261
EBP.2402	24V	24mA	Bailey BP23240241
EBP.2802	28V	24mA	Bailey BP23280241
EBP.3602	36V	20mA	Bailey BP23360201

ESP
Passende Lampenfassungen zu T1 BP 2.54mm Raster
Siehe Seite 22

T1 Light Bulbs BP Bi-Pin 3.17mm Pitch			
Order No	Voltage	Current	Number
34.05075	5V	75mA	
34.05075	10V	27mA	
34.18026	18V	26mA	
34.24024	24V	24mA	
34.28024	28V	24mA	DE280120

T1 ¼ Light Bulbs SM5s/8 Socket (SMF)			
Order No	Voltage	Current	Number
43.12050	12V	50mA	Alba A66233
43.14080	14V	80mA	8646
43.16030	16V	30mA	
43.24020	24V	20mA	
43.24035	24V	35mA	
43.28040	28V		

T1 ¼ Light Bulbs BP Bi-Pin 2.54mm Pitch			
Order No	Voltage	Current	Number
40.05060	5V	60mA	
40.06060	6V	60mA	
40.12040	12V	40mA	OL4032BPE
	12V	60mA	
40.16030	16V	30mA	A-7588-3D
40.24035	24V	35mA	
40.28024	28V	24mA	DH-2801
40.28040	28V	40mA	BQ243-50103A-LX

T1 ¼ Light Bulbs BP Bi-Pin 3.17mm Pitch			
Order No	Voltage	Current	Number
39.05060	5V	60mA	
39.12050	12V	50mA	
39.14081	14V	80mA	DI-140165
39.28040	28V	40mA	DI-280202

T1 ¼ Light Bulbs WT (Wire Terminal) T3.8				
Order No	Voltage	Current		
38.03530	3.5V	30mA		
38.11020	11V	20mA		
38.15020	15V	20mA		

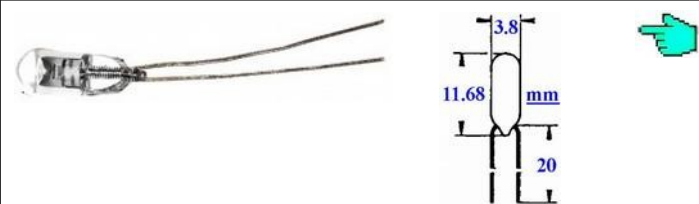

T1 ¼ Light Bulbs WT (Wire Terminal) T4.2				
Order No	Voltage	Current	Number	
42.05060	5V	60mA		
42.05115	5V	115mA		
42.06030	6V	30mA		
42.06060	6V	60mA		
42.16030	16V	30mA		
42.18040	18V	40mA		
42.18041	18V	40mA	AO-180160	
42.24035	24V	35mA		
42.24040	24V	40mA		
42.28025	28V	25mA		
42.28040	28V	40mA		
42.60020	60V	20mA		

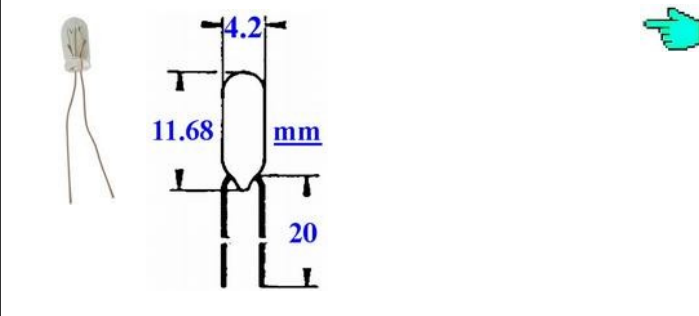

T1 ¼ Light Bulbs Special Screw Base 4.78x13.5mm				
Order No	Voltage	Current	Number	
36.13560	1.35V	60mA	8641 SS USA	
36.03190	3V	190mA	325 USA	
36.12050	12V	50mA	(T4SS120050F)	

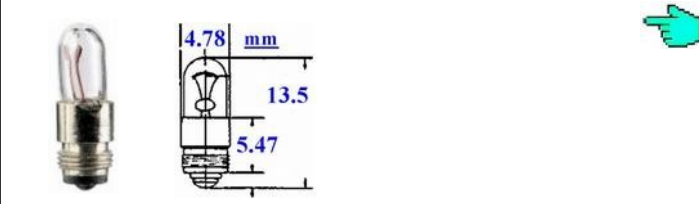

T1 ¼ Light Bulbs Knurled Screw Base KSB				
Order No	Voltage	Current	Number	
37.28040	28V	40mA	8623KS USA	







T1 ½ Light Bulbs Midget Screw E5 (E5/8) (LES Lilliput Edison Screw)				
Order No	Voltage	Current	Number	
44.25250	2.5V	250mA	E5/8 LES	
44.25300	2.5V	300mA	E5/8 LES	
44.25400	2.5V	400mA	E5/8 LES	
44.03015	3V	15mA	E5/8 LES	
44.03200	3.5V	200mA	E5/8 LES	
44.45200	4.5V	200mA	E5/8 LES	
44.06020	6V	20mA	E5.5/16 (6x21mm)	
44.06100	6V	100mA	E5/8 LES	
44.12060	12V	60mA	E5/8 LES	
44.12120	12V	120mA	E5.5/16 (6x21mm)	
44.14000	14V	??	E5/8 LES	
44.14040	14V	40mA	E5/8 LES	
44.24050	24V	50mA	E5.5/16 (6x21mm)	
44.24060	24V	60mA	E5/8 LES	

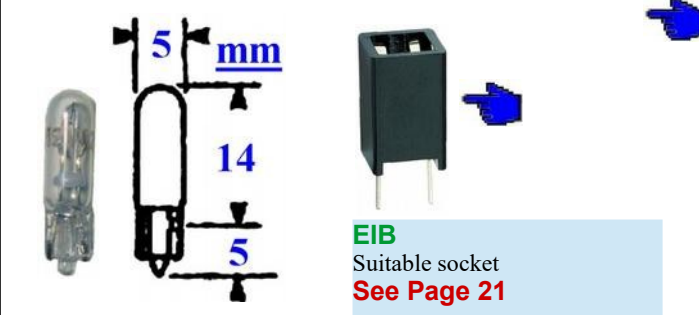

T1 ½ Light Bulbs Midget Screw E5 (E5/8) (LES Lilliput Edison Screw)				
Order No	Voltage	Current	Power	Number
ECC.0603	6V	30mA	180mW	Osram 2306
ECC.0616	6V	166mA	1W	
ECC.1203	12V	30mA	360mW	Osram 2322
ECC.1208	12V	83mA	1W	Osram 2321
ECC.2403	24V	30mA	720mW	Osram 2342
ECC.2404	24V		1W	Osram 2341

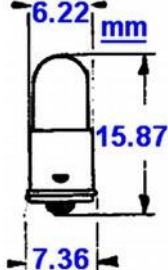

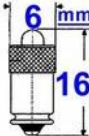

T1 1/2		Light Bulb with Cable		
Order No	Voltage	Current	Length Cable	
35.06040	6V	40mA	255 mm	
35.63040	6.3V	40mA		
35.12040	12V	40mA		
35.14040	14V	40mA		
35.24050	24V	50mA		
				
T1 1/2		Light Bulbs WT (Wire Terminal) T5.1		
Order No	Voltage	Current	Dimension	
48.60050	60V	50mA	5.1 x 12mm	
				
T1 3/4		Light Bulb MF (Midget Flange) (SX6s)		
Order No	Voltage	Current	Number	US Number
64.02040	2V	40mA		
64.35200	3.5V	200mA		
64.05060	5V	60mA	Bailey MF06050602	7333 USA
64.05115	5V	115mA	Bailey MF06051151	7335 USA
64.06040	6V	40mA	Bailey MF06060401	345 USA
64.06100	6V	100mA	Bailey MF06061001	
64.63200	6.3V	200mA	Bailey MF06062002	381 USA
64.63265	6.3V	265mA		
64.10014	10V	14mA	Bailey MF06100151	344 USA
64.10040	10V	40mA	Bailey MF06100401	367 USA
64.12040	12V	40mA	Bailey MF06120401	394 USA
64.12100	12V	100mA	Bailey MF06121001	727 USA
64.18040	18V	40mA	Bailey MF06180401	370 USA
64.24025	24V	25mA	Bailey MF06240251	
64.24050	24V	50mA	Bailey MF06240501	
64.24060	24V	60mA	Bailey MF06240601	3226 USA
64.28025	28V	25mA	Bailey MF06280251	721 USA
64.28030	28V	30mA	Bailey MF06280301	
64.28040	28V	40mA	Bailey MF06280401	385 USA
64.28060	28V	60mA	Bailey MF06280601	376 USA
64.28080	28V	80mA	Bailey MF06280801	729 USA
64.32040	32V	40mA		
64.36020	36V	20mA	Bailey MF06360201	730 USA
64.36030	36V	30mA	Bailey MF06360301	
64.48020	48V	20mA	Bailey MF06480201	3248 USA
64.48025	48V	25mA	Bailey MF06480251	6848 USA
64.48030	48V	30mA	Bailey MF06480301	723 USA
64.60020	60V	20mA	Bailey MF06600201	6195 USA
64.60030	60V	30mA	Bailey MF06600301	734 USA
				
				
T1 3/4		Glow Lamp MF (Midget Flange) (SX6s)		
Order No	Voltage	Description	Number	
64.220NE	220V	Neon	ORN3C3 ORNSC-3	
T1 3/4		LED Lamp MG (Midget Groove)		
Order No	Voltage	Description		
EBM.LED.24G	24VAC/VDC	Green		
				
				

T1 3/4 Light Bulb S5.7s (MG Midget Groove)				
Order No	Voltage	Current	Number	US Number
65.13560	1.35V	60mA	Bailey MG06010601	698 USA
EBM.0235	2.5V	350mA	Bailey MG06023501	266 USA
65.27060	2.7V	60mA	Bailey MG06020601	8704 USA
65.05020	5V	20mA	Bailey MG06050201	FG23 USA
65.05060	5V	60mA	Bailey MG06050601	7346 USA
65.05115	5V	115mA	Bailey MG06051151	7348 USA
EBM.0610	6V	100mA	Bailey MG06061001	
EBM.0620	6V	200mA	Bailey MG06062001	337 USA
EBM.0604	6V	40mA	Bailey MG06060401	8705 USA
65.63040	6.3V	40mA	Bailey MG06060402	7351 USA
65.63075	6.3V	75mA	Bailey MG06060751	8708 USA
EBM.1004	10V	40mA	Bailey MG06100401	397 USA
EBM.1204	12V	40mA	Bailey MG06120401	7354 USA
EBM.1210	12V	100mA	Bailey MG06121001	
EBM.1402	14V	20mA	Bailey MG06140201	
EBM.1408	14V	80mA	Bailey MG06140801	386 USA
EBM.1804	18V	40mA	Bailey MG06180401	346 USA
65.22040	22V	40mA	Bailey MG06220401	457 USA
EBM.2402	24V	25mA	Bailey MG06240251	890 USA
EBM.2405	24V	50mA	Bailey MG06240501	
65.24060	24V	60mA	Bailey MG06240601	
EBM.2802	28V	25mA	Bailey MG06280251	719 USA
65.28030	28V	30mA	Bailey MG06280301	
EBM.2804	28V	40mA	Bailey MG06280401	7355 USA
EBM.3603	36V	30mA	Bailey MG06360301	809 USA
65.48020	48V	20mA	Bailey MG06480201	805 USA
EBM.4802	48V	25mA	Bailey MG06480251	2250 USA
65.48030	48V	30mA	Bailey MG06480302	796 USA
EBM.6002	60V	20mA	Bailey MG06600201	6201 USA
65.60030	60V	30mA	Bailey MG06600301	735 USA

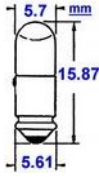







5.7 mm
15.87
5.61

ESM.x + ESW.xx
Suitable lamp sockets for T1-3/4 MG
See Page 22





T1 3/4 Glow Lamps S5.7s (MG Midget Groove)			
Order No	Voltage	Description	Number
EBM.G90	90V	Without dropping resistor	
65.110NE	120V	Neon	Bailey NG16110GG
EBM.G220	220V	Built-in dropping resistor	Bailey NG16220GC





T1 3/4 Light Bulbs E5.5 (MS Midget Screw)				
Order No	Voltage	Current	Number	US Number
67.25400	2.5V	400mA	Torch light bulb	
67.06040	6V	40mA	Bailey MS06060401	342 USA
67.06060	6V	60mA	Bailey MS06060601	526 USA
67.06200	6V	200mA	Bailey MS06062001	1768 USA
67.14080	14V	80mA	Bailey MS06140801	8362 USA
67.18040	18V	40mA	Bailey MS06180401	8536 USA
67.24040	24V	40mA	Bailey MS06240401	686 USA
67.28040	28V	40mA	Bailey MS06280401	399 USA
67.28060	28V	60mA	Bailey MS06280601	





5.7 mm
17.5
E5
5.33



T1 3/4 Multi LED Lampen (MG Midget Groove S5.7s/8)			
Order No	Voltage	Description	Type
86.1212R	12VDC	With 6 red LED	LD0602D12R
86.1224A	24VDC	With 6 yellow LED	LD0602D24A
	24VDC	With 6 green LED	LD0602D24G
86.1224R	24VDC	With 6 red LED	LD0602D24R



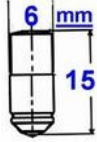

6 mm
15



T1 3/4 Multi LED Lamps (MF Midget Flange SX6s)			
Order No	Voltage	Description	Type
86.1024A	24VDC	With 6 yellow LED	LD0601D24A
	24VDC		LD0601D24G
86.1024R	24VDC	With 6 red LED	LD0601D24R



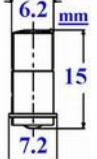

6.2 mm
15
7.2



T1 ¾ Light Bulbs BP Bi-Pin 3.17mm Pitch					
Order No	Voltage	Current	Number	US Number	
EBR.0235	2.5V	350mA	Bailey BP36023501	7868 USA	
66.05060	5V	60mA		7360 USA	
EBR.0235	6V	40mA	Bailey BP36060401	7945 USA	
EBR.0610	6V	100mA			
EBR.0620	6V	200mA	Bailey BP36062002	7328 USA	
66.63040	6.3V	40mA	Bailey BP36060402	7380 USA	
66.63075	6.3V	75mA	Bailey BP36060751	7377 USA	
66.63200	6.3V	200mA		7381 USA	
66.10040	10V	40mA	Bailey BP36100401	7367 USA	
EBR.1204	12V	40mA	Bailey BP36120401	7371 USA	
EBR.1210	12V	100mA			
EBR.1402	14V	20mA			
EBR.1408	14V	80mA	Bailey BP36140801	7382 USA	
EBR.1804	18V	40mA	Bailey BP36180401	7370 USA	
EBR.2402	24V	25mA			
EBR.2405	24V	50mA	Bailey BP36240501	7001 USA	
EBR.2802	28V	25mA			
EBR.2804	28V	40mA	Bailey BP36280402	7327 USA	
66.28080	28V	80mA			
66.30040	30V	40mA			
EBR.3603	36V	30mA			
66.48020	48V	20mA			
EBR.4802	48V	25mA	Bailey BP36480251	7748 USA	
EBR.6002	60V	20mA	Bailey BP36600201	7476 USA	

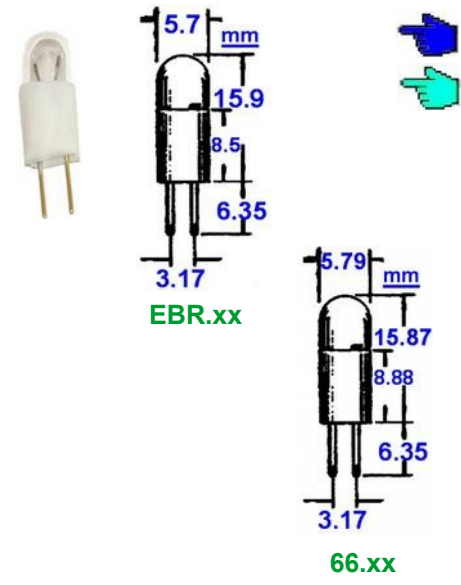

T1 ¾ Light Bulbs with Wedge Base (W2.1x9.5d)					
Order No	Voltage	Current	Power	Bailey Type	US Number
52.06300	6V	300mA			2509
ECD.0633	6V	333mA	2W	WB28063331	2501
52.06920	6V		2W	WB28063331	2501
52.06930	6V		3W	WB28065001	
52.06950	6V		5W	WB28068301	
52.63200	6.3V	200mA			
52.63250	6.3V	250mA		WB28062501	259
52.09270	9.6V	270mA			
ECD.1216	12V	166mA	2W		Osram 2820
52.12930	12V		3W	WB28122501	504
52.12950	12V		5W	WB28124001	501
52.24910	24V		1W		
ECD.2408	24V	83mA	2W	WB28240801	
52.24930	24V		3W	WB28241251	
52.24940	24V		4W	WB28241651	
52.28040	28V	40mA			
52.28060	28V	60mA		WB28280601	656
ECD.3605	36V	56mA	2W		
ECD.4804	48V	42mA	2W		

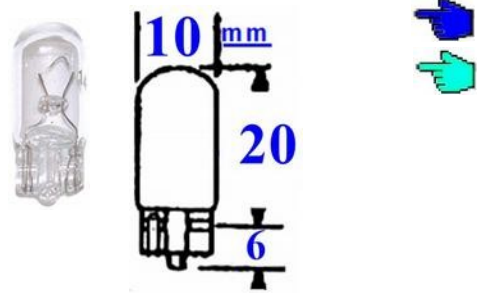

T1 ¾ Light Bulbs WT Wire Terminal					
Order No	Voltage	Current	Number	US Number	
EAZ.0235	2.5V	350mA	875mW	WE06023501	
63.05015	5V	15mA		WE06050151	
63.05060	5V	60mA		WE06050601	2200
63.05115	5V	115mA			
EAZ.0604	6V	40mA	240mW	WE06060401	1730
EAZ.0610	6V	100mA	600mW	WE06061001	714
EAZ.0620	6V	200mA	1.2W	WE06062001	1784
63.63200	6.3V	200mA		WE06062002	2181
EAZ.1204	12V	40mA	480mW	WE06120401	2174
EAZ.1206	12V	60mA	720mW	WE06120601	
	12V	120mA	1.44W		
EAZ.1402	14V	20mA	280mW		
EAZ.1408	14V	80mA	1.12W	WE06140801	2182
EAZ.1804	18V	40mA	720mW	WE06180401	2102
EAZ.2405	24V	50mA	1.2W	WE06240501	2176
EAZ.2804	28V	40mA	1.12W	WE06280401	2185
63.32040	32V	40mA			
EAZ.3603	36V	30mA	1.08W		
	48V	20mA		WE06480201	FW48
EAZ.4802	48V	25mA	1.2W		
63.48030	48V	30mA			
EAZ.6002	60V	20mA	1.2W	WE06600201	FW60

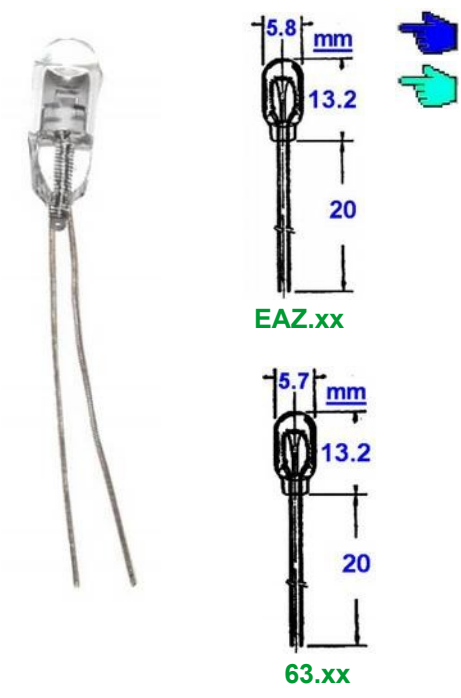

T1 ¾ Glow Lamp WT Wire Terminal					
Order No	Voltage	Current	Number	US Number	
70.84001	90V				NP2L

Glow Lamps WT Wire Terminal			
Order No	Voltage	Description	
ENE.2	55-67V	Without resistor	
ENE.2F	95V	Without resistor	
ENE.2R	220V	With resistor	

Light Bulbs SX3 Special Midget Flange			
Order No	Voltage	Current	Length
27.05115	5V	115mA	9.1mm
27.05000	5V		11.4mm
27.12060.SMF	12V	60mA	8mm
27.12060.LMF	12V		7.9mm

T5 Light Bulbs with Wedge Base (W2x4.6d)				
Order No	Voltage	Current	Bailey Type	US Number
50.01510	1.5V	100mA		
	3V	35mA		
50.03350	3V	350mA		
51.63200	6.3V	200mA		
50.09040	9V	40mA		
50.12912	12V	1.2W	WB20121001	2122
50.12920	12V	2W	WB20121651	2123
51.14040	14V	40mA		18
51.14080	14V	80mA	WB20140801	73
50.14914	14V	1.4W	WB20141001	74
50.24912	24V	1.2W	WB20240501	
51.28040	28V	40mA	WB20280401	85
51.60020	60V	20mA	WR20600201	86

T15 Light Bulbs with Wedge Base (W2x4.6d)				
Order No	Voltage	Current	Bailey Type	US Number
	12.8V	690mA	WB35130690	906
	12.8V	1A	WB35121000	912

Light Bulbs for Light Strings				
Order No	Voltage	Power		
ECL.1208	12V	1W		
	24V	1W		
Suitable Light String				

Light Bulbs with Fast-On Receptacle 6.3 x 0.8mm					
Order No	Voltage	Power			
ESD.L6	6V	1W			
ESD.L12	12V	1W			
ESD.L24	24V	1W			
Glow Lamps with Fast-On Receptacle 6.3 x 0.8mm					
Order No	Voltage	Power			
ESD.L220	230V	0.5W	Neon		
ESD.L220.5	230V	0.5W	Fluorescent for green lenses		
ESD.L380	380V		Neon		
Multi LED Lamps M10F (13 x 44mm)					
Order No	Voltage	Power			
85.9824G	24VDC	With 8 green LED			
85.9824A	24VDC	With 8 yellow LED			
85.9824R	24VDC	With 8 red LED			
LED Lamps with GU5.3 Socket 51x51mm					
Order No	Voltage	Colour	Angle	Power	
	6-24V	pure w hite	25°	3W	
	6-24V	pure w hite	100°	3W	
LED.6-24WW3W25	6-24V	w arm w hite	25°	3W	
	6-24V	w arm w hite	100°	3W	
LED Spot Cree with MR16 Socket					
Order No	Voltage	Angle	Colour		
LED.11-18-3WW	11-18VAC/DC	38°	w arm w hite		
	11-18VAC/DC	38°	w arm w hite		
Projection Lamps					
Order No	Voltage	Power	Measure	Socket (Type)	
89.06500	6V	5A	19x58mm	SX15s (Philips 6103)	
	24V	150W	32x97mm	Gy17q FUJI CYN	
87.11975	110V	750W	38x141mm	P28 (Seiko SP-12 SP12)	
87.11910	110V	1000W	38x141mm	P28 (Seiko SP-12 SP12)	
89.11150	110-120V	150W	26x90mm	Ba15s CEW/CFC	
	120V	400W	27x100mm	Ba15s T8-½-C13D (BEM)	
87.22976	220V	750W	38x141mm	P28 (Seiko S-12 SP12)	
87.22910	220V	1000W	38x141mm	P28 (Seiko S-12 SP12)	
89.22500	220V-250V	500W	40x210mm	E40	

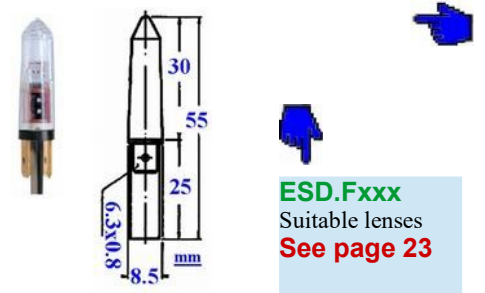

ESD.Fxxx
Suitable lenses
See page 23



Halogen Light Bulbs Low Voltage with G4 Socket

Order No	Voltage	Power	Measure	Type
87.06920	6V	20W	9x29mm	JC FHE
HG4.006.035	6V	35W	8x30mm	Bailey HG4006035F
	12V	10W	9x31mm	
HG4.012.010	12V	10W	8x30mm	Bailey HG4012010
HG4.012.020	12V	20W	8x30mm	Bailey HG4012020
HG4.024.020	24V	20W	8x30mm	Bailey HG4024020



Halogen Light Bulb with GY Socket

Order No	Voltage	Power	Measure	Socket	Type
	6V	35W	12x44mm	GY6.35	Philips 13094
87.12935	12V	35W	12x44mm	GY6.35	Osram 64432
87.12951	12V	50W	10x38mm	GY6.35	Osram 64440
87.12950	12V	50W	12x44mm	GY6.35	Philips 13079
87.12975	12V	75W		GY6.35	Osram 64450
87.23950	22.8V	50W	11x41mm	GY6.35	BT018566
87.24950B	24V	50W	11x33mm	GY6.35	(Osram 64445)
87.24951	24V		11x45mm	GY9.5	H24501
HY6.024.250X	24V	250W	15x54mm	GY6.35	HY6024250X
HY6.240.150	240V	150W	14x54mm	GY6.35	HY6240150



Halogen Light Bulb with GY Socket

Order No	Voltage	Power	Measure	Socket	Type
87.12952	12V	50W	50x50mm	GX5.3/GU5.3	EXN (22314)
87.20150	20V	150W	50x43mm	GX5.3 DDL	Philips 13094
87.36934	36V	340W	50x47mm	GX5.3 DDL	ERV (H24501)
	230V	1000W	24x67.5mm	G6.35-25	Osram 64575



Halogen Light Bulb with GZ Socket

Order No	Voltage	Power	Measure	Socket	Type
HLX.64627	12V	100W	42x50mm	GZ6.35	



Halogen Light Bulb with Rafi F9 Socket

Order No	Voltage	Power	Measure	Socket	Type
	12V	120mA	9x28mm	Rafi F9	901212



Halogen Lamps with R7s Socket

Order No	Voltage	Power	Measure	Type
87.22975	22.8V	75W	10x63mm	
	240V	250W	11x117.6mm	
	230V	300W	10x117mm	
	230V	300W	11x117.6mm	Philips 300T3Q/CL
	240V	300W	11x117.6mm	
	230V	500W	10x117mm	
87.22750	230V	750W	11x189mm	
87.21000	230V	1000W	11x189mm	



Fluorescent Lamps

Order No	Voltage	Power	Measure	Type
84.22906	220V	6W	16x212mm	TL6W/33
	220V	8W	16x288mm	TL8W/96



Microscope Lamp with Bajonet Socket for grey and black Zeiss Microscope

Order No	Voltage	Power	Measure	Description
	6V	15W	13x52mm	Carl Zeiss 380177 38-01-77



Fuse Type Pilot Lamp SF 6.3x30mm

Order No	Voltage	Current	Power	Bailey Type
ECF.0610	6V	100mA	600mW	SF3106100
ECF.0620	6V	200mA	1.2W	SF3106200
ECF.0630	6V	300mA	1.8W	SF3106300
ECF.0810	8V	100mA	800mW	SF3108100
	8V	200mA	1.6W	(SF3108250)
ECF.0830	8V	300mA	2.4W	SF3108300
ECF.1206	12V	60mA	720mW	
ECF.1210	12V	100mA	1.2W	SF3112100
ECF.1408	14V	80mA	1.12W	
ECF.1415	14V	150mA	2.1W	
ECF.2408	24V	80mA	1.92W	



Festoon Light Bulb

Order No	Voltage	Current	d	L	Bailey Type
90.11203	12V	3W	6mm	31mm	S63112250
90.12403	24V	3W		31mm	S63124125
90.61203	12V	3W	6mm	36mm	S63612003
	12V	3W		36mm	S63612003
90.81203	12V	3W	6mm	38mm	~S63912003
90.82403	24V	3W		38mm	~S63924003
91.81202	12V	2W	8mm	29mm	~S72812002
91.82405	24V	5W		29mm	~S72824005
91.10603	6V	3W	8mm	31mm	S73106003
91.13203	32V	3W		31mm	S73132003
91.90603	6V	3W	8mm	38mm	~S73906003
91.91203	12V	3W			~S73912003
91.92403	24V	3W			~S73924003
92.924002	24V	2W	11mm	38mm	~S83924002
92.91210	12V	10W	11mm	39mm	S83912010
92.93005	30V	5W			S83930005
92.40603	6V	3W	11mm	44mm	S84406003
	24V	3W			S84424003G
93.12905	12V	5W	15mm	44mm	S84512005
93.12910	12V	10W			S84512010
	24V	10W			S84524010
93.28905	28V	5W			
93.60905	60V	5W			S84560005



92.42403

T4.5 Telecommunication Lamp (4.5 x 16.5mm) with Socket T4.5

Order No	Voltage	Current		Bailey Type
45.06050	6V	50mA		T4506050
45.06070	6V	70mA		T4506070
45.12020	12V	20mA		T4512020
45.12040	12V	40mA		T4512040
45.16060	16V	60mA		
45.24020	24V	20mA		T4524020
EBU.2405K	24V	50mA		T4524050
45.30020	30V	20mA		T4530020
45.30040	30V	40mA		T4530040
45.36020	36V	20mA		T4536020
45.60020	60V	20mA		T4560020
45.110NE	110V	1.5A	Neon	



T4.6 Telecommunication Light Bulbs (4.6 x 22mm) with Socket T4.6				
Order No	Voltage	Current	Power	Bailey Type
EBU.0602	6V	20mA	120mW	T4606020
46.06040	6V	40mA		T4606040
EBU.0605	6V	50mA	300mW	T4606050
EBU.0610	6V	100mA		T4606100
EBU.0620	6V	200mA	1.2W	T4606200
EBU.1202	12V	20mA	240mW	T4612020
EBU.1204	12V	40mA	480mW	T4612040
46.12050	12V	50mA		T4612050
46.12080	12V	80mA		
46.12100	12V	100mA		T4612100
EBU.1802	18V	25mA	450mW	T4618025
EBU.2402	24V	20mA	480mW	T4624020
46.24030	24V	30mA		T4624030
EBU.2405	24V	50mA	1.2W	T4624050
46.28020	28V	20mA		T4628020
46.28040	28V	40mA		T4628040
46.28050	28V	50mA		
46.30020	30V	20mA		T4630020
46.30040	30V	40mA		T4630040
46.30050	30V	50mA		
EBU.3602	36V	20mA	720mW	T4636020
EBU.4802	48V	20mA	960mW	T4648020
EBU.6002	60V	20mA	1.2W	T4660020
46.70020	70V	20mA		T4670020
46.220NE	220V	500mA	Glimm Neon	

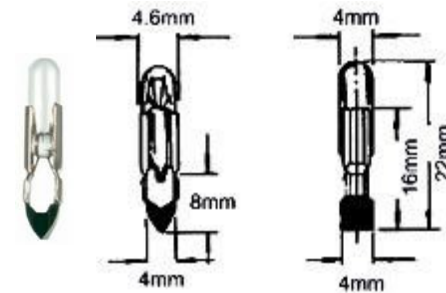

ESU.x
Suitable fittings for T4.6 light bulbs
See Page 22



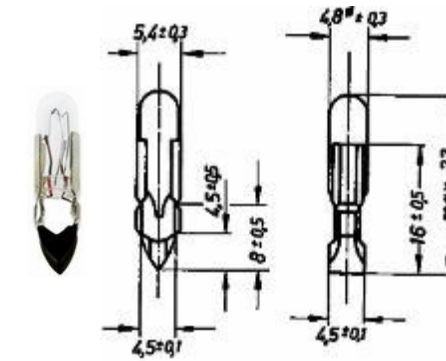

T5.5K Telecommunication Light Bulbs (5.4 x 22mm) with Socket T5.5K				
Order No	Voltage	Current	Power	Bailey Type
54.06100	6V	100mA		T5606100
54.06200	6V	200mA		T5606200
54.12020	12V	20mA		T5612020
EBW.1204K	12V	40mA		T5612040
54.12040	12V	40mA		T5612040
54.12100	12V	100mA		T5612100
54.24020	24V	20mA		T5624020
54.24025	24V	25mA		
54.24030	24V	30mA		T5624030
54.24040	24V	40mA		T5624040
54.24050	24V	50mA		T5624050
54.28040	28V	40mA		T5628040
54.28050	28V	50mA		T5628050
54.30020	30V	20mA		T5630020
54.30040	30V	40mA		T5630040
54.36020	36V	20mA		T5636020
54.48020	48V	20mA		T5648020
54.60020	60V	20mA		T5660020
54.110NE	110V	1.5A	Neon	





T5.5 Multi LED (54 x 30mm) with Socket T5.5		
Order No	Voltage	Description
	24VDC	With 4 yellow Chip LED
	24VDC	With 4 green Chip LED
	24VDC	With 4 red Chip LED





T5.5 Telecommunication Light Bulbs (5.4 x 30mm) with Socket T5.5				
Order No	Voltage	Current	Power	Bailey Type
EBW.0602	6V	20mA	120mW	T5506020
55.06040	6V	40mA		T5506040
EBW.0605	6V	50mA	300mW	T5506050
EBW.0610	6V	100mA	600mW	T5506100
EBW.0620	6V	200mA	1.2W	T5506200
EBW.1202	12V	20mA	240mW	T5512020
55.12040	12V	40mA		T5512040
EBW.1205	12V	50mA	600mW	T5512050
55.12080	12V	80mA		T5512080
EBW.1210	12V	100mA	1.2W	T5512100
EBW.1802	18V	25mA	450mW	T5518025
EBW.2402	24V	20mA	480mW	T5524020
55.24030	24V	30mA		T5524030
55.24040	24V	40mA		T5524040
EBW.2405	24V	50mA	1.2W	T5524050
EBW.2802	28V	20mA	560mW	T5528020
EBW.2804	28V	40mA		T5528040
EBW.2805	28V	50mA	1.4W	T5528050
55.30020	30V	20mA		T5530020
55.30040	30V	40mA		T5530040
55.30050	30V	50mA		T5530050
EBW.3602	36V	20mA	720mW	T5536020
EBW.3603	36V	35mA	1.26W	T5536030
55.36040	36V	40mA		T5536040
55.36050	36V	50mA		T5536050
55.42020	42V	20mA		
EBW.4802	48V	25mA	1.2W	T5548025
55.48030	48V	30mA		T5548030
55.48040	48V	40mA		
55.55020	55V	20mA		
EBW.6002	60V	20mA	1.2W	T5560020
55.60030	60V	30mA		T5560030
55.70020	70V	20mA		T5570020
55.110GF	110V	1.5A	Fluorescent with integrated resistor	
	110V	1.5A	Glow lamp with built in resistor	
EBW.G220	220V	1.5A	Glow lamp with built in resistor	
EBW.G220G	220V	1.5A	Fluorescent lamp	

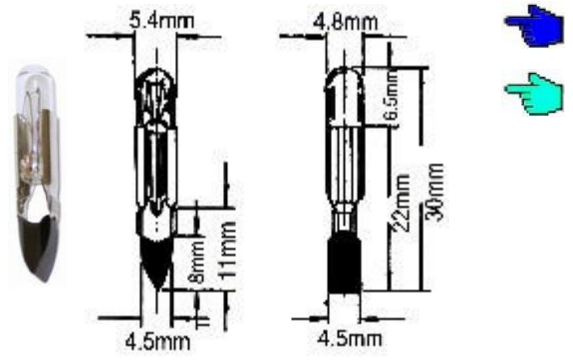

T6.8 Telecommunication Light Bulb (6.8 x 46.5mm) with Socket T6.8				
Order No	Voltage	Current	Power	Bailey Type
68.06020	6V	20mA		T6806020
68.06040	6V	40mA		T6806040
68.06050	6V	50mA		T6806050
EBT.0610	6V	100mA	600mW	T6806100
	6V	100mA		T6806100
EBT.0620	6V	200mA	1.2W	T6806200
EBT.1202	12V	20mA	240mW	T6812020
EBT.1204	12V	40mA		T6812040
EBT.1205	12V	50mA	600mW	T6812050
EBT.1210	12V	100mA	1.2W	T6812100
68.12120	12V	120mA		T6812120
EBT.2402	24V	20mA	480mW	T6824020
68.24040	24V	40mA		T6824040
EBT.2405	24V	50mA	1.2W	T6824050
68.24080	24V	80mA		T6824080
EBT.2804	28V	40mA	1.26W	T6828040
68.30020	30V	20mA		T6830020
EBT.3004	30V	40mA		T6830040
68.30050	30V	50mA		T6830050
EBT.3602	36V	20mA	720mW	T6836020
EBT.3603	36V	35mA	1.26W	T6836035
68.36040	36V	40mA		T6836040
68.36050	36V	50mA		T6836050
68.42020	42V	20mA		
EBT.4802	48V	25mA	1.2W	T6848025
68.48040	48V	40mA		T6848040
68.48050	48V	50mA		T6848050
EBT.6002	60V	20mA	1.2W	T6860020
68.60040	60V	40mA		T6860040
68.60050	60V	50mA		T6860050
68.60060	60V	60mA		T6860060
68.70020	70V	20mA		T6870020
68.110NE	110V	1.5A	Glow lamp with integrated resistor	
68.220GF	220V	1.5A	Fluorescent integrated resistor	
EBT.G220	220V	1.5A	Neon for green lenses	

Glow Lamps with 150mm Cable			
Order No	Voltage	Cut Out	Colour
ESE.A64	220VAC	6mm	yellow transparent
ESE.A65			green transparent
ESE.A69			clear transparent
ESE.A62			red transparent

Glow Lamps with Fast-On 6.3x0.8mm			
Order No	Voltage	Cut Out	Colour
ESE.C104	220VAC	10mm	yellow transparent
ESE.C105			green transparent
ESE.C102			red transparent

Glow Lamps with Fast-On 6.3x0.8mm			
Order No	Voltage	Cut Out	Colour
ESE.D134	220VAC	13mm	yellow transparent
ESE.D135			green transparent
ESE.D132			red transparent

Indicator Light with Fast-On 6.3x0.8mm

Order No	Voltage	Size	Colour
SAN.85143	230V	14x43mm	yellow
SAN.BGL22	230V	22x30mm	red
SAN.85002	230V	22x30mm	yellow



Ba9s Light Bulb Sockets

Order No	Socket	Description
EEU.B9	Ba9s	With solder tags
EEO.B9		With solder tags
		With solder tags
EFB.B9		With solder tags
EEA.B9		Vertical PCB mounting



E10 Light Bulb Sockets

Order No	Socket	Description
	E10	With solder tags
EHA		With solder tags
EHA.H1		Mounting piece fits EHA
		Mounting piece 90° fits EHA
EFA.R9		With solder tags
EEG		With solder tags
		Horizontal PCB mounting
		Vertical PCB mounting
		Vertical PCB mounting
EGA.0		Screw terminal



E10 Light Bulb Sockets

Order No	Socket	Description
ESB.6	E10	Signal lamp holder blue
ESB.9		Signal lamp holder clear
ESB.5		Signal lamp holder green
ESB.3		Signal lamp holder orange
ESB.2		Signal lamp holder red

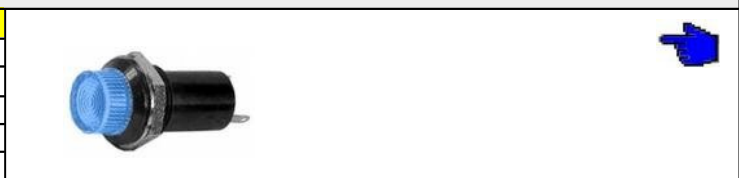





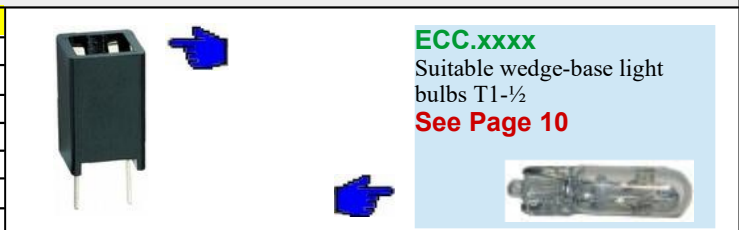



W2x4.6d Light Bulb Socket

































Order No	Socket	Description
EIB	W2x4.6d	PCB mounting for wedge base T1-½







TH25 Indicator Lamp

Order No	Suitable Lenses					
	blue	yellow	green	orange	red	clear
ESP	SAL.RK6	SAL.RK4		SAL.RK3	SAL.RK2	SAL.RK9
<p>EBP.xxxx or 33.xxxxx Suitable bi-pin bulbs See Page 9</p>    						
<p>Or use 5mm LEDs</p>						
   						

TH5 + TH25 Indicator Lamp

Order No	Suitable Lenses					
	blue	yellow	green	orange	red	clear
ESM.A	SAL.AK6	SAL.AK4	SAL.AK5	SAL.AK3	SAL.AK2	SAL.AK9
ESW.AA	SAR.AK6	SAR.AK4	SAR.AK5	SAR.AK3	SAR.AK2	SAR.AK9
<p>EBM.xxxx or 65.xxxxx Suitable light bulbs T1-3/4 Midget Groove See Page 12</p>   						
Order No	Suitable Lenses					
	blue	yellow	green	orange	red	clear
ESM.B	SAL.BK6	SAL.BK4	SAL.BK5	SAL.BK3	SAL.BK2	SAL.BK9
	SAR.BK6	SAR.BK4	SAR.BK5	SAR.BK3	SAR.BK2	SAR.BK9
<p>EBM.xxxx or 65.xxxxx Suitable light bulbs T1-3/4 Midget Groove See Page 12</p>   						
Order No	Suitable Lenses					
	blue	yellow	green	orange	red	clear
ESM.C	SAL.CK6	SAL.CK4	CAL.CK5	SAL.CK3	SAL.CK2	SAL.CK9
ESW.AC	SAR.CK6	SAR.CK4	SAR.CK5	CAR.CK3	SAR.CK2	SAR.CK9
<p>EBM.xxxx or 65.xxxxx Suitable light bulbs T1-3/4 Midget Groove See Page 12</p>   						
                       						

T4.6		Signal Lamp with Solder Terminal			
Order No	Colour	Ø			
ESU.4	yellow	11mm	<p>EBU.xxxx or 46.xxxxx Suitable telecommunication bulbs T4.6 See Page 12</p>   	 	
	green				
ESU.9	clear				
ESU.2	red				

Signal Lights (for incandescent bulbs and glow lamps)

Order No	Colour	Description
ESD.FD174	yellow	Arrow
ESD.FD179	clear	
ESD.FD172	red	
ESD.FC144	yellow	Square 14x14mm
ESD.FC145	green	
ESD.FC149	clear	
ESD.FC142	red	
ESD.FA124	yellow	Round 12mm
ESD.FA125	green	
ESD.FA129	clear	
ESD.FA122	red	



ESD.xxxx

Suitable incandescent bulbs and glow lamps

See Page 15



Subminiature Lamps (fits T³/₄ Micro Midget Flange Light Bulbs)

Order No	Colour	Description
ESY.6	blue	PCB mounting
ESY.4	yellow	
ESY.5	green	
ESY.9	clear	



EBX.xxxx or 26.xxxxx

Suitable light bulbs
Micro Midget Flange

See Page 8

