

Relays

Prices see shop.griederbauteile.ch

SSR Solid State Relays	Page 1					
DIL/SIL Relays	Page 2					
Sub-Miniature-Relays	Page 3 - 10					
Miniature-Relays	Page 11 - 18					
Cradle Relays	Page 19 - 20					
Industrial-Relays	Page 21 - 26					
Micro Contactor Relays	Page 27					

SSR Solid State Relay							
Order No	Min Voltage	Rated Voltage	Max Voltage	Drop out	Current	Finder Series	Omron
	V	V	V	V	mA		
SRS.E12.2AC	4	12	24	1	5		G3R-OA 202SZN
SRS.G12.10AC	4	12	24	1	5		G3PA-210B-VD
SRS.GH10	Power device cartridge for SRS.G12.10AC						G32A-A10-VD



SRS.E12.2AC



SRS.G12.10AC



SRS.GH10



Retro components are only available as long as stock lasts.

Dual-In-Line Reed Relays

Mateable with a 14-pin IC-socket

Order No	Min Voltage VDC	Rated Voltage VDC	Max Voltage VDC	Drop Out VDC	Coil Current mA	Resistance Ω	Contact	Guenther Series
SRW.5	3.5V	5V	15V	1	13	384.6	1x On/Off oFd, oA	3570 1301
SRW.5AD			15V	1	13	384.6	1x On/Off mFd, mA	3570 1301
SRW.E5			21V	1	10	500	1x On/Off oFd, oA	3570 1210
SRW.E5AD			21V	1	10	500	1x On/Off mFd, mA	3570 1210
SRW.EE5			10V	1	25	200	2x On/Off oFd, oA	3572 1220
SRW.U5			11V	1	25	200	1x On/On oFd, oA	3563 1231
SRW.12	8V	12V	18V	2	23	521.8	1x On/Off oFd, oA	3570 1301
SRW.12AD			18V	2	23	521.8	1x On/Off mFd, mA	3570 1301
SRW.E12			24V	2	12	1000	1x On/Off oFd, oA	3570 1210
SRW.E12AD			24V	2	12	1000	1x On/Off mFd, mA	3570 1210
SRW.EE12			19V	2	24	500	2x On/Off oFd, oA	3572 1220
SRW.U12			21V	2	24	500	1x On/On oFd, oA	3563 1231
SRW.U12.5	16V	24V	18V	2	500	500	1x Ein/Ein oFd	3573 1231
SRW.24			32V	4	12	2000	1x On/Off oFd, oA	3570 1301
SRW.24AD			32V	4	12	2000	1x On/Off mFd, mA	3570 1301
SRW.E24			45V	4	11	2181.8	1x On/Off oFd, oA	3570 1210
SRW.E24AD			45V	4	11	2181.8	1x On/Off mFd, mA	3570 1210
SRW.EE24			44V	4	11	2181.8	2x On/Off oFd, oA	3572 1220
SRW.U24	44V	4	11	2181.8	1x On/On oFd, oA	3563 1231		

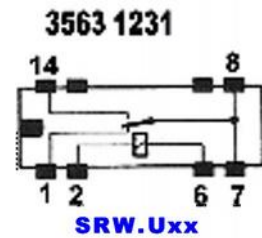
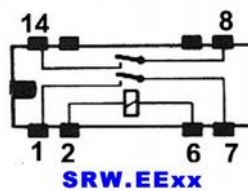
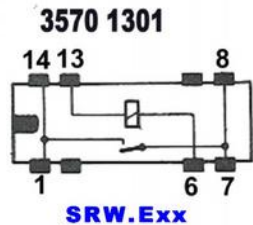
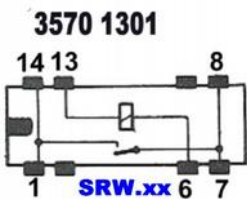
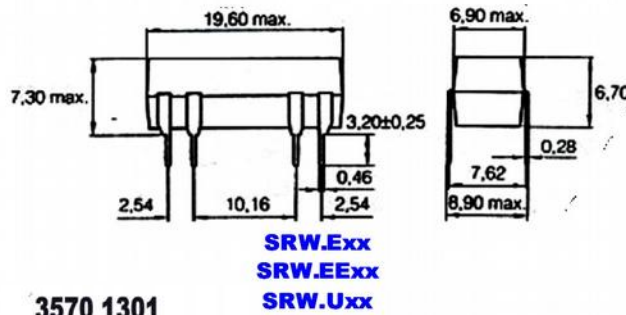
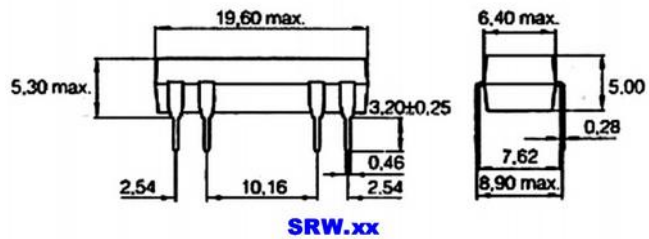

Single-In-Line Reed Relays

Contact: NO Normally Open, with diode



Order No	Min Voltage VDC	Rated Voltage VDC	Max Voltage VDC	Drop Out VDC	Coil Current mA	Resistance Ω	Type	Guenther Series
SRW.RU24AD	18V	24V	40V			2150	MSS4 1A	3585-1331-243

Subminiature Relays SPDT 110VAC/0.5A



Order No	Min voltage VDC	Rated voltage VDC	Max voltage VDC	Drop out VDC	Coil current mA	Resistance Ω	Omron Series
SRU.3	2.1	3	3.3	0.3	150	20	G2E-184P-M-US
SRU.6	4.2	6	6.6	0.6	75	80	
SRU.9	6.3	9	9.9	0.9	50	180	

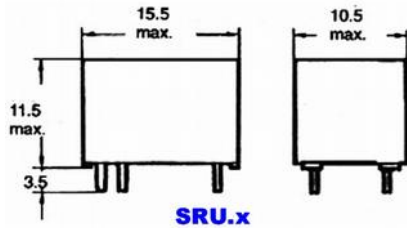
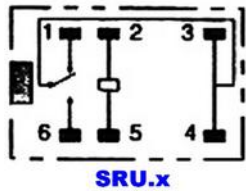

Subminiature Relay DPDT 110VAC/0.3A

Mateable with a 16-pin IC-socket



Order No	Min Voltage VDC	Rated Voltage VDC	Max Voltage VDC	Drop out VDC	Coil current mA	Resistance Ω	Finder Series	Omron Series	replaces Omron Series
SRU.2U5	3.8	5	6	0.5	111.1	45	30.22	G5V-2	G2VN-237PL
SRU.2U6	4.5	6	7.2	0.6	100	60			
SRU.2U12	9	12	14.4	1.2	42.8	280			
SRU.2U24	18	24	28.8	2.4	22.8	1050			

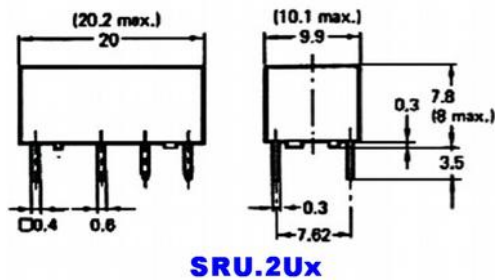
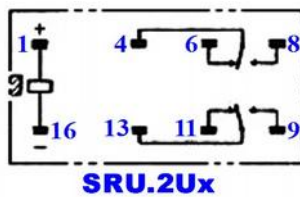

Subminiature Relays DPDT 125VAC/0.5A



Order No	Min Voltage	Rated Voltage	Max Voltage	Drop Out	Coil Current	Resistance	Omron Series
	VDC	VDC	VDC	VDC	mA	Ω	
SRR.H2U3	2.3	3	4.5	0.3	46.7	64.3	G6H-2
SRR.H2U5	3.8	5	7.5	0.5	28.1	177.9	
SRR.H2U6	4.5	6	9	0.6	23.3	257.5	
SRR.H2U9	6.8	9	13.5	0.9	15.5	580.6	
SRR.H2U12	9	12	18	1.2	11.7	1025.6	
SRR.H2U24	18	24	31.2	2.4	8.3	2891.6	

Subminiature PCB Relays (Sugar Cube) SPDT 250VAC/10A

Dimensions: W=15.5mm L=19mm H=16mm



Order No	Min Voltage	Rated Voltage	Max Voltage	Drop Out	Coil Current	Resistance	Finder Series	Equivalent to Omron
	VDC	VDC	VDC	VDC	mA	Ω		
SRY.1U6	4.5	6	7.8	0.6	66.7	90	36.11	G5L-117P
SRY.1U12	9	12	15.6	1.2	33.3	360.4		
SRY.1U24	18	24	31.2	2.4	16.7	1437.1		

Subminiature Relays SPDT 125VAC/0.4A (30VDC/2A)

Order No	Min Voltage	Rated Voltage	Max Voltage	Drop Out	Coil Current	Resistance	Omron Series
	VDC	VDC	VDC	VDC	mA	Ω	
SRR.E1U3	2.1	3	3.9	0.3	66.7	45	G6E-134P-US
SRR.E1U5	3.5	5	6.5	0.5	40	125	
SRR.E1U6	4.2	6	7.8	0.6	33.3	180.2	
SRR.E1U9	6.3	9	11.7	0.9	22.2	405.4	
SRR.E1U12	8.4	12	15.6	1.2	16.7	718.6	
SRR.E1U24	16.8	24	31.2	2.4	8.3	2891.6	

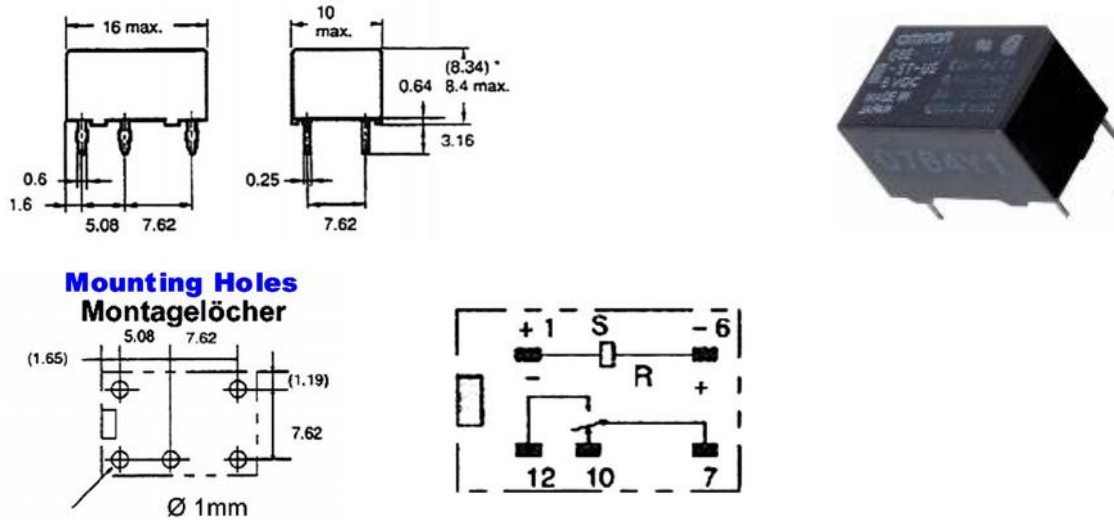

**Subminiature Relays Bifurcated SPDT 125VAC/0.4A
With double winding**

Order No	Min Voltage	Rated Voltage	Max Voltage	Drop Out	Coil Current	Resistance	Omron Series
	VDC	VDC	VDC	VDC	mA	Ω	
SRR.EB1U1	1.1	1.5	1.9	1.1	133	11.3	G6EK-134P
SRR.EB1U3	2.1	3	3.9	2.1	66.7	45	
SRR.EB1U6	4.2	6	7.8	4.2	33.3	180.2	
SRR.EB1U9	6.3	9	11.7	6.3	22.2	405.4	
SRR.EB1U12	8.4	12	15.6	8.4	16.7	718.6	
SRR.EB1U24	16.8	24	31.2	16.8	8.3	2891.6	

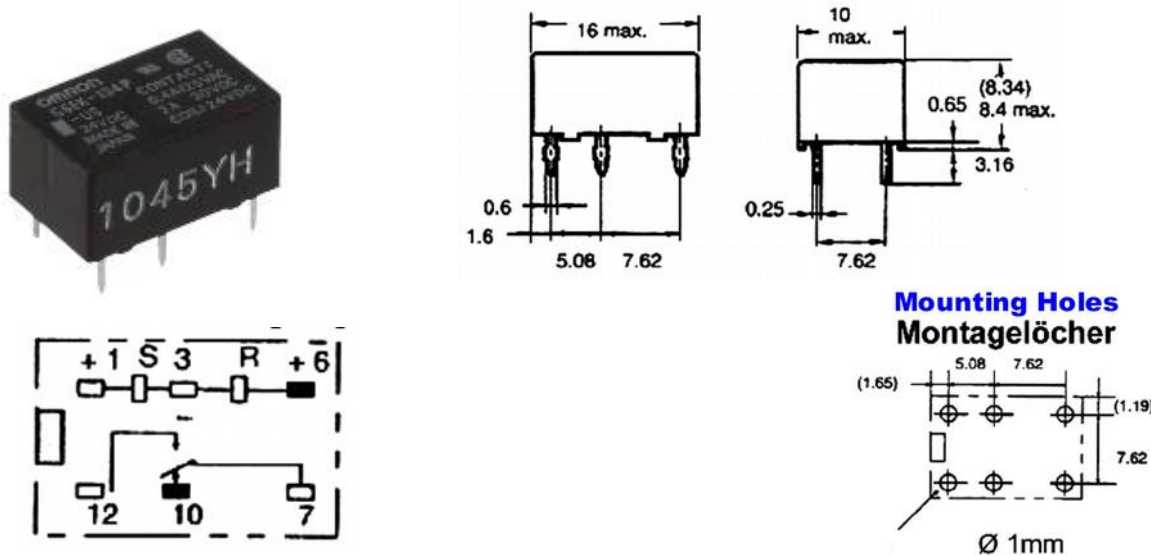

Subminiature Relays 4PDT 125VAC/0.3A

Order No	Min Voltage VDC	Rated Voltage VDC	Max Voltage VDC	Drop Out VDC	Coil Current mA	Resistance Ω	Omron Series
SRR.A4U3	2.1	3	4.5	0.3	106.8	28.1	G6A-434P
SRR.A4U4	3.15	4.5	6.75	0.45	71.2	63.2	
SRR.A4U5	3.5	5	7.5	0.5	64	78.1	
SRR.A4U6	4.2	6	9	0.6	53.3	112.6	
SRR.A4U9	6.3	9	13.5	0.9	35.6	252.8	
SRR.A4U24	16.8	24	36	2.4	13.3	1804.5	
SRR.A4U48	34	48	72	4.8	6.7	7164.2	

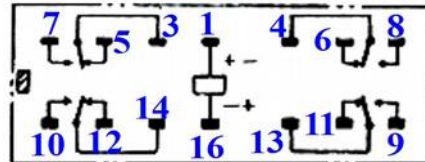
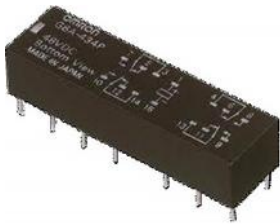

**Mounting Holes
Montagelöcher**

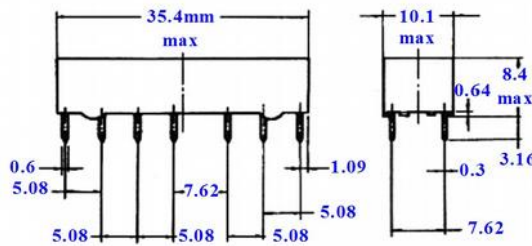
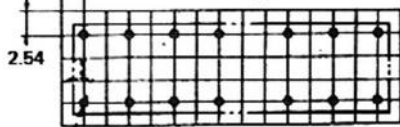

Surface Mounting Relays DPDT 125VAC/0.3A

Application examples: Telephones, communication equipment, measuring instruments, Biro automation equipment and audiovisual products

Order No	Min Voltage VDC	Rated Voltage VDC	Max Voltage VDC	Drop Out VDC	Coil Current mA	Resistance Ω	Omron Series
SRR.K2U5	4	5	7.5		21.1	237	G6K-2P
SRR.K2U12	9.6	12	18		9.1	1315	

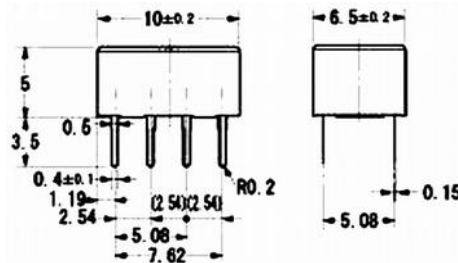

Subminiature Relays 4PDT 125VAC/0.3A
Bistable with double winding

Order No	Min Voltage	Rated Voltage	Max Voltage	Drop Out	Coil Current	Resistance	Omron Series
	VDC	VDC	VDC	VDC	mA	Ω	
SRR.AB4U1	1.1	1.5	2.2	1.1	214.3	7	
SRR.AB4U3	2.1	3	4.5	2.1	106.8	28.1	
SRR.AB4U4	3.2	4.5	6.7	3.2	71.2	63.2	
SRR.AB4U5	3.5	5	7.5	3.5	64	78.1	
SRR.AB4U24	16.8	24	36	16.8	13.3	1804.5	
SRR.AB4U48	34	48	72	34	6.7	7164.2	



SRR.AB4Ux

**Mounting Holes
Montagelöcher**

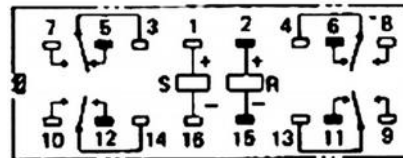
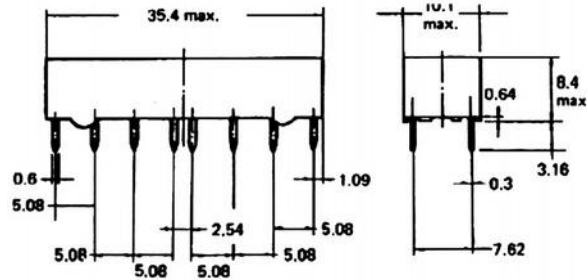
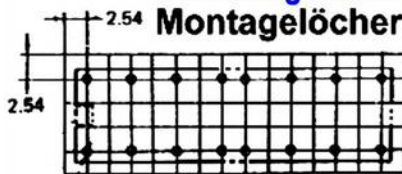

Relays 4PDT 1.3W

Order No	Min Voltage	Rated Voltage	Max Voltage	Coil Current SET	Resistance SET	Coil Current RESET	Resistance RESET	Omron Series
	VDC	VDC	VDC	mA	Ω	mA	Ω	
SRQ.B4U5	4	5	5.5	246	20.3	266	18.8	LZN-4K
SRQ.B4U6	4.8	6	6.6	224	26.8	210	28.6	
SRQ.B4U24	19.2	24	26.4	57.8	415	53.3	450	
SRQ.B4U48	38.4	48	52.8	30	1600	24.6	1950	

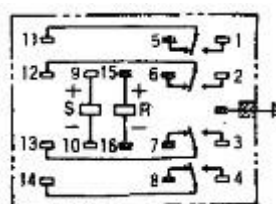
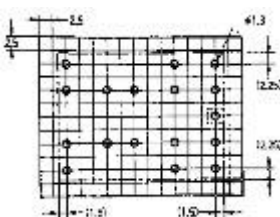
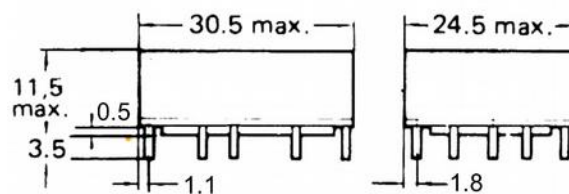

Subminiature Relays SPST-NO 250VAC 5A Monostable

DIL connection in 2.54mm pitch
Directly controllable by integrated circuits

Order No	Min Voltage	Rated Voltage	Max Voltage	Drop Out	Coil Current	Resistance	Omron Series	FinderSeries
	VDC	VDC	VDC	VDC	mA	Ω		
SRR.B1E6	4.2	6	7.8	0.6	33.3	180.2	G6B-1114P-US	32.21
SRR.B1E12	8.4	12	15.6	1.2	16.7	718.6		
SRR.B1E24	16.8	24	31.2	2.4	8.3	2891.6		

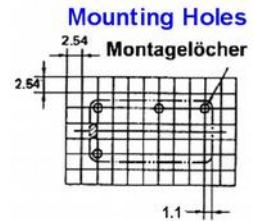
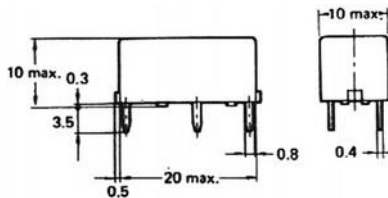
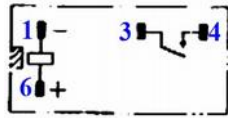

Subminiature Relays SPST-NO 250VAC 5A Bistable

Order No	Min Voltage	Rated Voltage	Max Voltage	Drop Out	Coil Current	Resistance	Omron Series	FinderSeries
	VDC	VDC	VDC	VDC	mA	Ω		
SRR.BB1E3	2.1	3	3.9	2.1	93.2	32.2	G6BK-1114P-US	
SRR.BB1E5	3.5	5	6.5	3.5	56	89.3		
SRR.BB1E6	4.2	6	7.8	4.2	46.8	128.2		
SRR.BB1E12	8.4	12	15.6	8.4	23.3	515		
SRR.BB1E24	16.8	24	31.2	16.8	11.7	854.7		

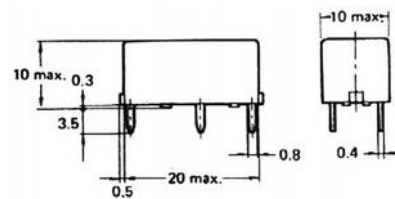
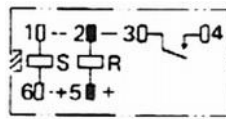
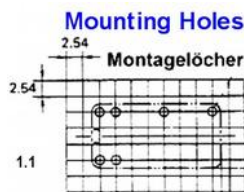

Matching print socket

Order No	Omron Series	FinderSeries
SRR.BS	P6B-04P	
SRR.BBS	P6B-06P	

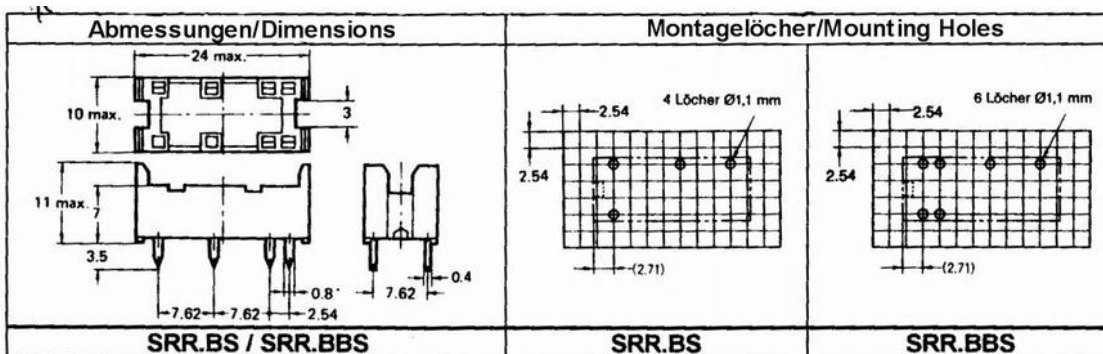

Subminiature Relays SPST-NO 250VAC 8A/10A

Due to the low power consumption of the excitation coils, the relays can be controlled directly by integrated circuits.

Order No	Min Voltage VDC	Rated Voltage VDC	Max Voltage VDC	Drop Out VDC	Coil Current mA	Resistance Ω	Type	Omron Series
SRR.C1E3	2.1	3	3.9	0.3	67	44.8	1xOn/Off	G6C-2117P-US-SV
SRR.C1EA3	2.1	3	3.9	0.3	67	44.8	1xOn 1xOff	
SRR.C1EA24	16.8	24	31.2	2.4	8.3	2891.6	1xOn 1xOff	



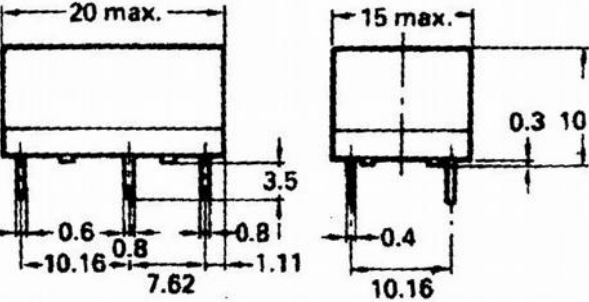

**SRR.C1E3
SRR.C1E6**

Löcher/Mounting Holes

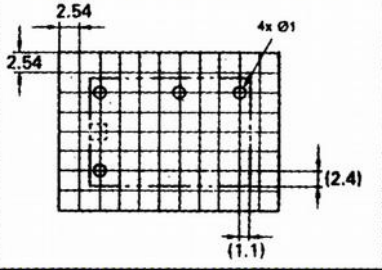

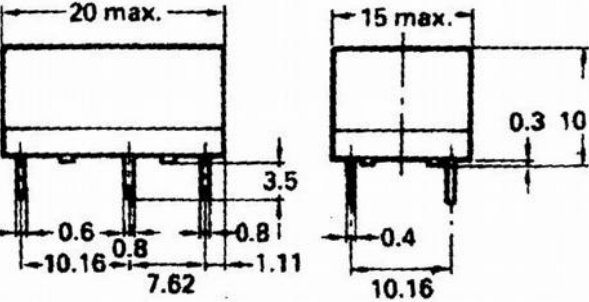

SRR.C1EA24

Löcher/Mounting Holes

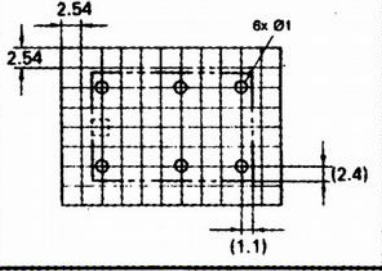

Heavy Duty Miniature Relays SPDT 250VAC/8A (30VDC/5A)

Suitable for applications in household heaters and industry.

Order No	Min Voltage VDC	Rated Voltage VDC	Max Voltage VDC	Coil Current mA	Resistance Ω	Type	Finder Series	Omron Series
SRR.R1U12	8.4	12	18	18.3	655		43.41	G6RN-1
SRR.R1U24	16.8	24	36	9.2	2620			



Finder

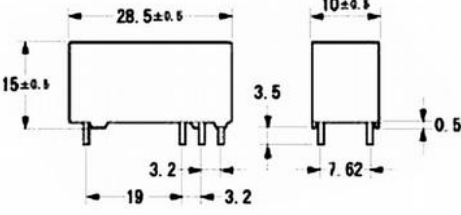



Omron

**Print-Miniatur-Relais SPDT 250VAC/10A
DC-Version**



Order No	Min Voltage	Rated Voltage	Max Voltage	Drop Out	Coil Resistance	Resistance	Finder Series	Omron Series
	VDC	VDC	VDC	VDC	mA	Ω		
SRM.C1U5	3.5	5	5.5	0.75	106	47	40.31	G2R-1
SRM.C1U6	4.2	6	6.6	0.9	88	68		
SRM.C1U12	8.4	12	13.2	1.8	44	275		
SRM.C1U14	10.2	14	21		47			
SRM.C1U24	16.8	24	26.4	3.6	22	1100		
SRM.C1U48	33.6	48	52.8	7.2	11.5	4170		

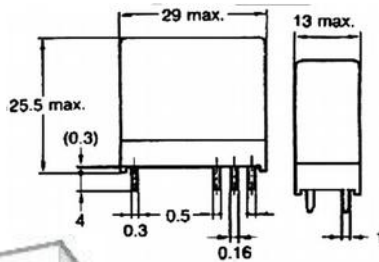

**Anschlussbelegung
Connection Assignment**

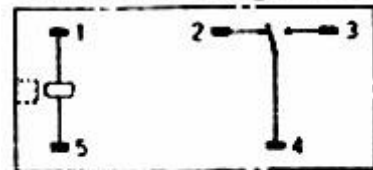

**Ansicht auf Anschlüsse
View on Connections**

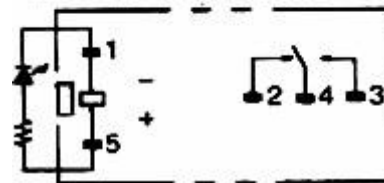

Suitable Sockets

Order No		Finder Series	equivalent Lumberg
SRM.SS1	Base with screw terminals for DIN rail or screw mounting	95.83.3 SPA	
SRM.SP1	Socket for PCB mounting	95.13.1	RF 5 E
SRM.SH	Suitable retaining spring for SRM.SP1		HF-83



**PCB-Miniature-Relays SPDT 250VAC/10A
AC-Version**

Order No	Min Voltage	Rated Voltage	Max Voltage	Drop Out	Coil Current	Resistance	Type	Finder Series	Omron Series
	VAC	VAC	VAC	VAC	mA	Ω			
SRM.C1U12AC	9.6	12	13.2	3.6	93	129	50Hz	40.61	G2R-1-SN
SRM.C1U24AC	19.2	24	26.4	7.2	46.5	516.1	50Hz		
SRM.C1U50AC	40	50	55	15	22	2272.8	50Hz		
SRM.C1U220AC	184	230	253	69	4.6	50000	50Hz		
SRM.SS1	Suitable socket w ith screw connection							95.83.3 SPA	
SRM.SP1	Matching print socket							95.13.1	
SRM.SH	Matching headband to print socket								

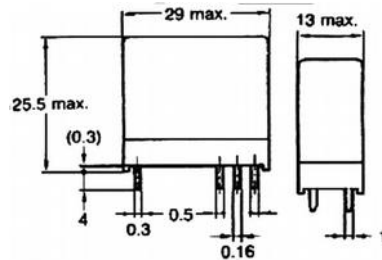

**Anschlussbelegung
Connection Assignment**

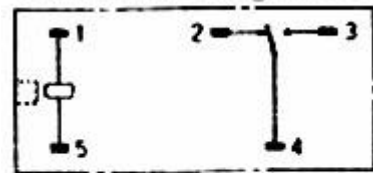

**Ansicht auf Anschlüsse
View on Connections**

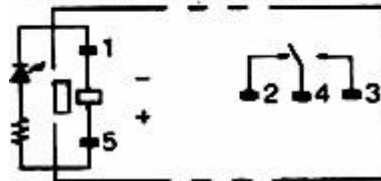

PCB-Miniature-Relays SPDT 250VAC/16A

SRM.D1U230AC	184	230	253		5	28000		40.61	
--------------	-----	-----	-----	--	---	-------	--	-------	--

PCB-Miniature-Relays SPDT 250VAC/16A

SRM.DH1250AC	184	230	253		4.2	38000		41.61	
--------------	-----	-----	-----	--	-----	-------	--	-------	--



Miniature Relays SPDT 250V/10A DC-Version (with flat tabs)

Order No	Min Voltage VDC	Rated Voltage VDC	Max Voltage VDC	Drop Out VDC	Coil Current mA	Resistance Ω	Finder	Omron Series
SRM.CK1U12	8.4	12	13.2	1.8	44	275		G2R-1-SN
SRM.CKF1U12		12					46.61	
SRM.CK1U24	16.8	24	26.4	3.6	22	1100		

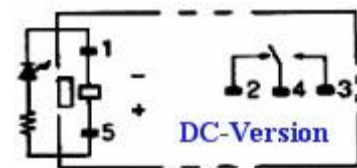
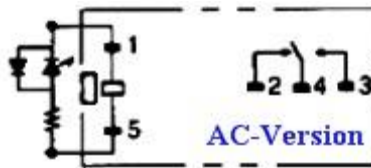

**Anschlussbelegung
Connection Assignment**

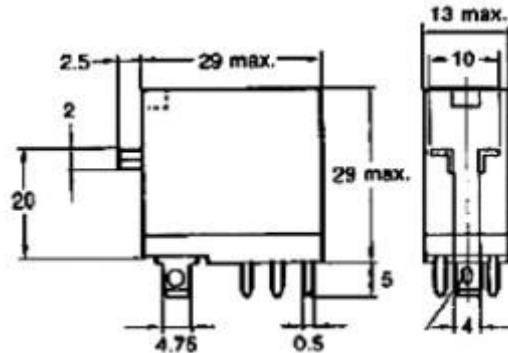
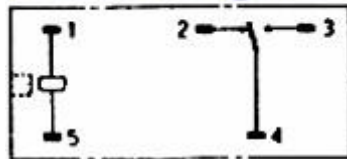

AC-Version (with flat tabs)

	VAC	VAC	VAC	VAC	mA	Ω		
SRM.CK1U12AC	8.4	12	13.2	1.8	93	129		G2R-1-SN
SRM.CK1U24AC	16.8	24	26.4	3.6	46.5	516.1		G2R-1-SN
SRM.CKF1U24AC		24						G2R-1-T

Miniature-PCB-Relays SPDT 250VAC/8A

Order No	Min Voltage VDC	Rated Voltage VDC	Max Voltage VDC	Coil Current mA	Resistance Ω	Version	Omron Series	
SRX.H3	2.1	3	3.3	173	17.3	horizontal	G2L-1	
SRX.V3	2.1	3	3.3	173	17.3	vertical		
SRX.H5	3.5	5	5.5	100	50	horizontal		
SRX.V5	3.5	5	5.5	100	50	vertical		
SRX.H6	4.2	6	6.6	75	80	horizontal		
SRX.V6	4.2	6	6.6	75	80	vertical		
SRX.H12	8.4	12	13.2	36.4	329.7	horizontal		
SRX.H24	16.8	24	26.4	20	1200	horizontal		
SRM.24	21	24	35		990			DFG 3213 1011 1300
SRM.F1U24DC		24						Finder 34.51
SRX.H48	33.6	48	52.8	10.2	4705.9	horizontal		
SRX.V48	33.6	48	52.8	10.2	4705.9	vertical		

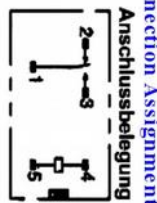
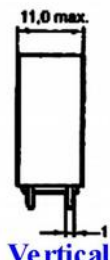
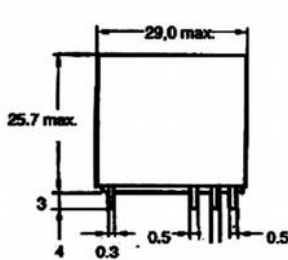
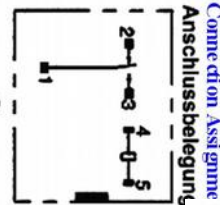
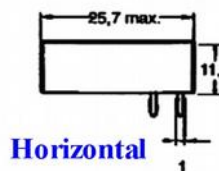
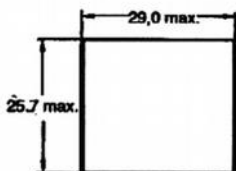

Miniature-Relays SPDT up to 16A

Order No	Min Voltage	Rated Voltage	Max Voltage	Drop Out	Coil Current	Resistance	Omron Series	Finder Series
	VDC	VDC	VDC	VDC	mA	Ω		
SRM.D1U5	3.5	5	5.5	0.75	106	47	G2R-1-E	40.61
SRM.D1U6	4.2	6	6.6	0.9	88	68		
SRM.D1U12	8.4	12	13.2	1.8	44	275		
SRM.DH112	8.4	12	18		360	33.3		41.61
SVR-12A		12				720		
SRM.D1U24	16.8	24	26.4	3.6	22	1100	G2R-1-E	40.61
SRM.DH124	16.8	24	36		1440	16.7		41.61
SRM.41.24DC		24						41.31
SRM.D1U48	33.6	48	52.8	7.2	11.5	4170	G2R-1-E	40.61

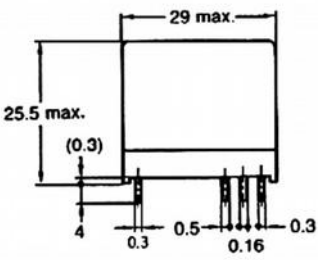
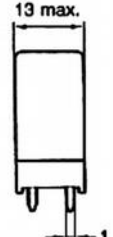
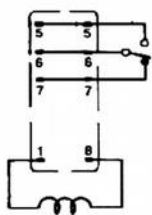

SRM.DHx

**connection assignment
Anschlussbelegung**



SRM.SPS2



SRM.SS2

Suitable socket for SRM.Dx

Order No		Finder Series	Lumberg
SRM.SS2	Relay socket including mounting bracket with screw terminals for 35mm DIN rail or screw mounting.	95.85.3SPA	
SRM.SPS2	Relay socket for PCB mounting and lateral screw connections.		RFK-5

Miniature-PCB-Relays DPDT 250VAC/5A DC-Version

Order No	Min Voltage	Rated Voltage	Max Voltage	Drop Out	Coil Current	Resistance	Finder	Omron Series
	VDC	VDC	VDC	VDC	mA	Ω		
SRM.2U5	3.5	5	5.5	0.75	106	47	40.52	G2R-2
SRM.2U6	4.2	6	6.6	0.9	88	68		
SRM.2U12	8.4	12	13.2	1.8	44	275		
SRM.2U24	16.8	24	26.4	3.6	22	1100		
SRM.2U48	33.6	48	52.8	7.2	11.5	4170		
SRL.24	21	24	35			990		

DC-Version
Ansicht auf Anschlüsse
view on connections

SRM.2Ux

SRL.24

Anschlussbelegung
connection assignment

AC-Version
Ansicht auf Anschlüsse
view on connections

Print/PCB-Version

SRM.SP2

SRM.SS2

AC-Version

	VAC	VAC	VAC	VAC	mA	Ω		Omron Series
SRM.2U6AC	4.8	6	6.6	1.6	186	32.2	50Hz	G2R-2
SRM.2U12AC	9.6	12	13.2	3.6	93	129	50Hz	
SRM.2U24AC	19.2	24	26.4	7.2	46.5	516.1	50Hz	
SRM.2U50AC	40	50	55	15	22	2273	50Hz	
SRM.2U220AC	184	230	253	69	4.6	50000	50Hz	

Suitable sockets for SRM.2Ux

Best.Nr.		Finder Series	Lumberg
SRM.SS2	Relay socket including mounting bracket with screw terminals for 35mm DIN rail or screw mounting.	95.85.3SPA	
SRM.SP2	Relay socket for PCB mounting grid 5mm	95.15.2 SMA	RF-8

Miniature-PCB-Relays DPDT 250VAC/5A DC-Version

Order No	Min Voltage	Rated Voltage	Max Voltage	Drop Out	Coil Current	Resistance	Finder Series	Omron Series
	VDC	VDC	VDC	VDC	m A	Ω		
SRM.CK2U6	4.2	6	6.6	0.9	88	68		G2R-2 -SN
SRM.CK2U12	8.4	12	13.2	1.8	44	275		
SRM.CK2U24	16.8	24	26.4	3.6	22	1100		
SRM.CKF2U12		12					46.52	

DC-Version
Ansicht auf Anschlüsse
view on connections

SRM.CKF2U12

AC-Version
Ansicht auf Anschlüsse
view on connections

Anschlussbelegung
connection assignment

Steckanschlüsse

plug-In terminal

SRM.CK2Ux

SRM.SK2

AC-Version

Order No	Min Voltage	Rated Voltage	Max Voltage	Drop Out	Coil Current	Resistance		Omron Series
	VAC	VAC	VAC	VAC	m A	Ω		
SRM.CK2U6AC	4.2	6	6.6	0.9	186	32.2	50Hz	G2R-2 -SN
SRM.CK2U12AC	8.4	12	13.2	1.2	93	129	50Hz	
SRM.CK2U24AC	16.8	24	26.4	3.6	46.5	516.1	50Hz	
SRM.CK2U230AC	184	230	253	69	4.6	50000	50Hz	

Suitable socket for SRM.CK2Ux

Best.Nr.		Finder Series	Omron Series
SRM.SK2	Relay socket with screw terminals for DIN rail or screw mounting.	97.02 SPA	P2RF-08-E BY OMZ

Miniature-PCB-Relays SPST-NO 250VAC/15A

Order No	Min Voltage	Rated Voltage	Max Voltage	Drop Out	Coil Current	Resistance		Omron Series
	VDC	VDC	VDC	VDC	mA	Ω		
SRZ.1E12	9.6	12	13.2	1.2	66.7	180		G4W-1112P- US-TV8
SRZ.1E24	19.2	24	26.4	2.4	33.3	720.7		



SRZ.1Ex

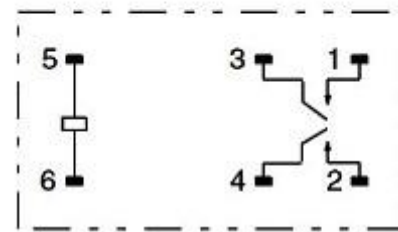
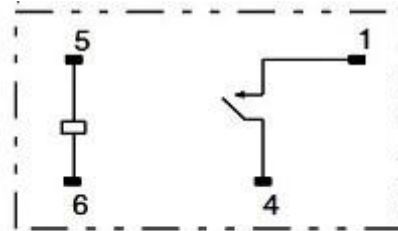
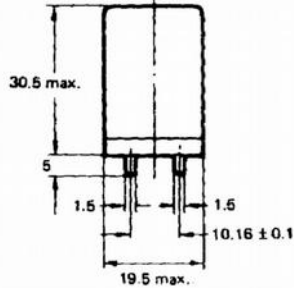
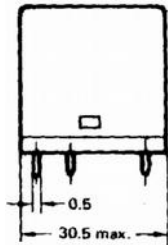

SRZ.2Ex

Miniature-PCB-Relays DPST-NO 250VAC/10A

Order No	Min Voltage	Rated Voltage	Max Voltage	Drop Out	Coil Current	Resistance		Omron Series
	VDC	VDC	VDC	VDC	mA	Ω		
SRZ.2E12	9.6	12	13.2	1.2	66.7	180		G4W-2212P- US-TV5
SRZ.2E24	19.2	24	26.4	2.4	33.3	720.7		

Flat Relay DPDT 110VAC/1A

Order No	Min Voltage	Rated Voltage	Max Voltage	Drop Out	Coil Current	Resistance		Omron Series
	VDC	VDC	VDC	VDC	mA	Ω		
SRQ.M2U5	3.5	5	8.5	0.5	58.8	85		LZLNQ-203-US
SRQ.M2U6	4.2	6	10.2	0.6	42.9	139.9		
SRQ.M2U24	16.8	24	40.8	2.4	12	2000		
SRQ.M2U48	33.6	48	81.6	4.8	6.9	6956.5		

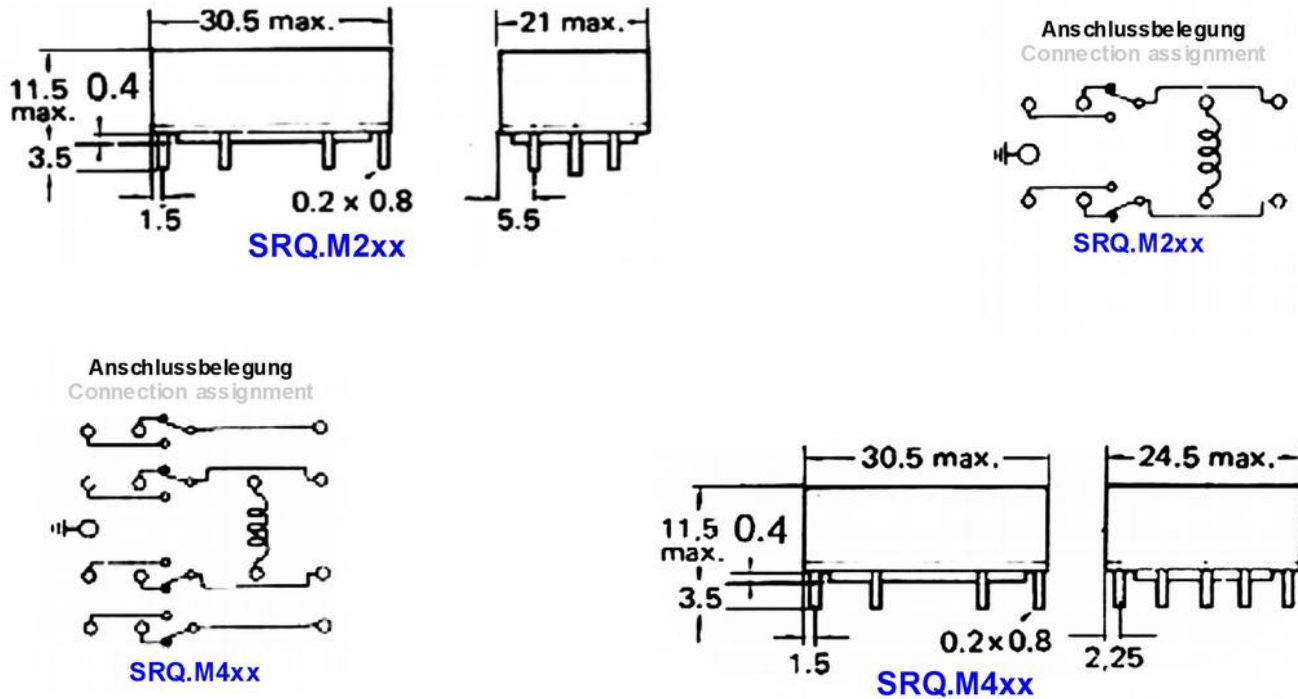

Flat-Relays 4PDT 110VAC/1A

Order No	Min Voltage	Rated Voltage	Max Voltage	Drop Out	Coil Current	Resistance		Omron Series
	VDC	VDC	VDC	VDC	mA	Ω		
SRQ.M4U5	3.5	5	7	0.5	96.2	52		LZLNQ-403-US
SRQ.M4U6	4.2	6	8.4	0.6	70.6	85		

Cradle Relay DPDT 150VDC/125VAC 2A 35W

Order No	Min Voltage	Rated Voltage	Max Voltage	Coil Current	Resistance	Siemens Series
	VDC	VDC	VDC	mA	Ω	
SRO.2U12	5.3	12	24	50	240	V23154-C0719-B104
SRO.2U48	13	48	54	28.2	1702.2	
SRF.2K	Matching socket w ith solder terminals					
SRF.2P	Matching socket w ith print connections					





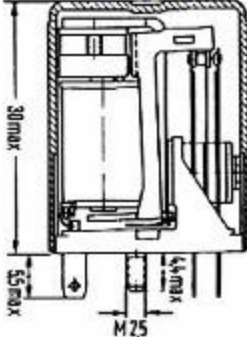

SRO.2Uxx

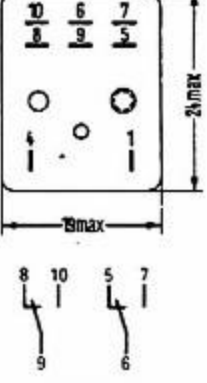

SRO.2Uxx



21 max
19 max



SRF.2K + SRF.2P

Cradle Relay 4PDT 150VDC/125VAC 2A 35W

Order No	Min Voltage	Rated Voltage	Max Voltage	Coil Current	Resistance	Siemens Series
	VDC	VDC	VDC	mA	Ω	
SRO.4U6	2.8	6	7.5		28	V23154-D0716-B110
SRO.4U12	5.5	12	16.5	80	150	
SRO.4U15	10	15	18	68.2	220	
SRF.4P	Matching socket w ith print connections					





SRO.4Uxx

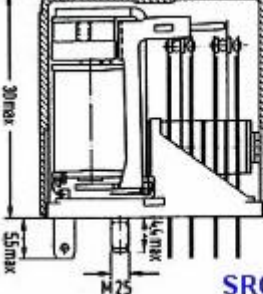

SRO.4Uxx

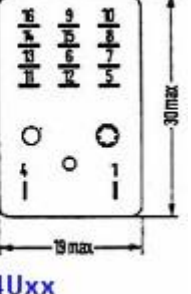

30 max
19 max

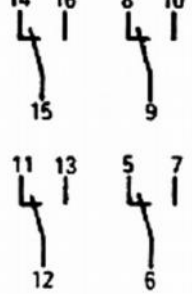

Cradle Relay DPDT 250VDC/250VAC 5A 140W

Order No	Min Voltage	Rated Voltage	Max Voltage	Coil Current	Resistance	Siemens
	VDC	VDC	VDC	mA	Ω	
SRN.2U12	6.4	12	17	80	150	V23154-D0716-B110
SRN.2U24	10.8	24	32	43.6	550.5	
SRN.2U48	21	48	54	28.2	1702.2	
SRF.4P	Matching socket w ith print connections					

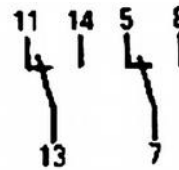
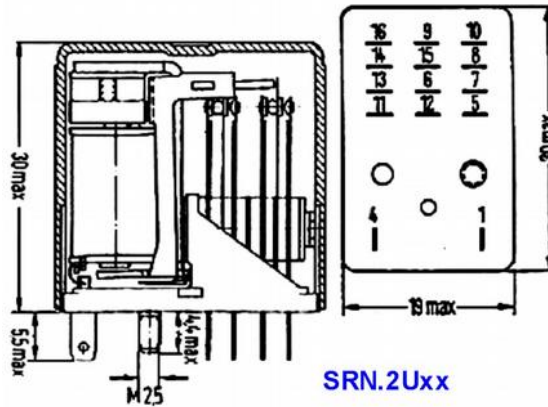

Cradle Relay 4PDT 150VDC/125VAC 2A 35W

Order No	Min Voltage	Rated Voltage	Max Voltage	Coil Current	Resistance	Siemens
	VDC	VDC	VDC	mA	Ω	
SRN.4U24	15.1	24	32	45.2	531	
SRN.4U48	29.6	48	58	28.2	1702.2	
SRF.6P	Matching socket w ith print connections					

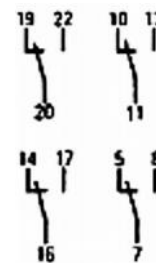
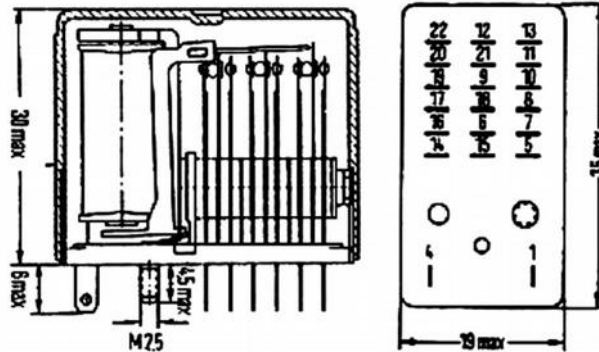
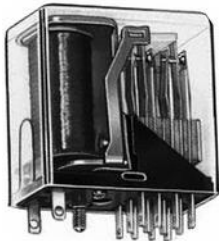

**General Purpose Relay DPDT 230VAC 10A
DC-Version**

Order No	Min Voltage	Rated Voltage	Max Voltage	Drop Out	Coil Current	Resistance	Finder Series	Equivalent to Omron Series
	VDC	VDC	VDC	VDC	mA	Ω		
SRD.2U6	4.8	6	6.6	0.6	150	40	55.32	MY2-US-SV
SRD.2U12	9.6	12	13.2	1.2	75	160		
SRD.2U24	19.2	24	26.4	2.4	36.9	650		

Suitable Sockets

SRD.AS2	Socket with solder lugs	94.22	PY-08
SRD.AP2	Socket for PCB mounting	94.12	PY08-02



Finder



Omron

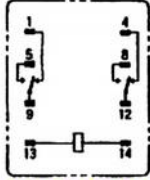

SRD.2Ux

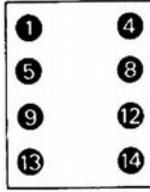

PY-08-02



SRD.AP2

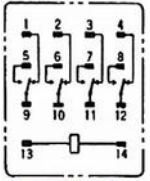

SRD.4Ux

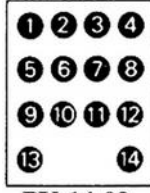

PY-14-02



SRD.AP4

**General Purpose Relay 4PDT 230VAC 7A
DC-Version**

Order No	Min Voltage	Rated Voltage	Max Voltage	Drop Out	Coil Current	Resistance	Finder Series	Equivalent to Omron Series
	VDC	VDC	VDC	VDC	mA	Ω		
SRD.4U6	4.8	6	6.6	0.6	150	40	55.34	MY4-US-SV
SRD.4U12	9.6	12	13.2	1.2	75	160		
SRD.4U24	19.2	24	26.4	2.4				

Suitable Sockets

SRD.AS4	Socket with solder lugs	94.24	PY-14
SRD.AP4	Socket for PCB mounting	94.14	PY14-02

**General Purpose Relays DPDT 230VAC 10A
AC-Version**

Order No	Min Voltage	Rated Voltage	Max Voltage	Drop Out	Coil Current	Resistance	Finder Series	Equivalent to Omron Series
	VAC	VAC	VAC	VAC	mA	Ω		
SRD.2U6AC	4.8	6	6.6	1.8	214.1	28	55.32	MY2-US-SV
SRD.2U12AC	9.6	12	13.2	3.6	106.5	112.7		
SRD.2U24AC	19.2	24	26.4	7.2	53.8	446.1		
SRD.2U230AC	184	230	253	69	4.6	50000		

Suitable Sockets

SRD.AS2	Socket with solder lugs	94.22	PY-08
SRD.AP2	Socket for PCB mounting	94.12	PY08-02
SRD.BS2	Relay socket with screw terminals for 35mm DIN rail or screw mounting	94.02.SPA	PYF-08A-E
SRD.BS4	Relay socket with screw terminals for 35mm DIN rail or screw mounting	94.04.SPA	PYF-14A-E

The image displays various relay models and their components. On the left, two relays are shown: a Finder relay and an Omron relay. In the center, there are two terminal diagrams: SRD.2Ux (top) and SRD.4Ux (bottom). To the right, there are two relay socket models: SRD.BS2 (top) and SRD.BS4 (bottom). Further right, there are two PCB mounting socket models: SRD.AP2 (top) and SRD.AP4 (bottom). On the far right, there are two terminal block diagrams: PY-08-02 (top) and PY-14-02 (bottom). Blue arrows point to specific parts of the diagrams.

**General Purpose Relays 4PDT 230VAC 7A
AC-Version**

Order No	Min Voltage	Rated Voltage	Max Voltage	Drop Out	Coil Current	Resistance	Finder Series	Equivalent to Omron Series
	VAC	VAC	VAC	VAC	mA	Ω		
SRD.4U6AC	4.8	6	6.6	0.6	214.1	28	55.34	MY4-US-SV
SRD.4U12AC	9.6	12	13.2	1.2	106.5	112.7		
SRD.4U24AC	19.2	24	26.4	2.4	53.8	446.1		
SRD.4U230AC	184	230	253	69	4.6	50000		

Suitable Sockets

SRD.AS4	Socket with solder lugs	94.24	PY-14
SRD.AP4	Socket for PCB mounting	94.14	PY 14-02
SRD.BS4	Relay socket with screw terminals for 35mm DIN rail or screw mounting	94.04.SPA	PYF-14A-E

Power Relay DPDT 220VAC/10A DC-Version

Order No	Min Voltage VDC	Rated Voltage VDC	Max Voltage VDC	Drop Out VDC	Coil Current mA	Resistance Ω	Finder Series	Omron Series
SRC.A2U6	4.8	6	6.6	0.6	150	40	56.32	LY2
SRC.A2U12	9.6	12	13.2	1.2	75	160		
SRC.A2U24	19.2	24	26.4	2.4	36.9	650		
SRC.AP2	For PCB mounting						96.12	PT08-02
SRC.AS2	Base with solder lugs							PT08
SRC.BS2	Relay socket with screw terminals for DIN rail or screw mounting						96.72SMA	PTF08A-E

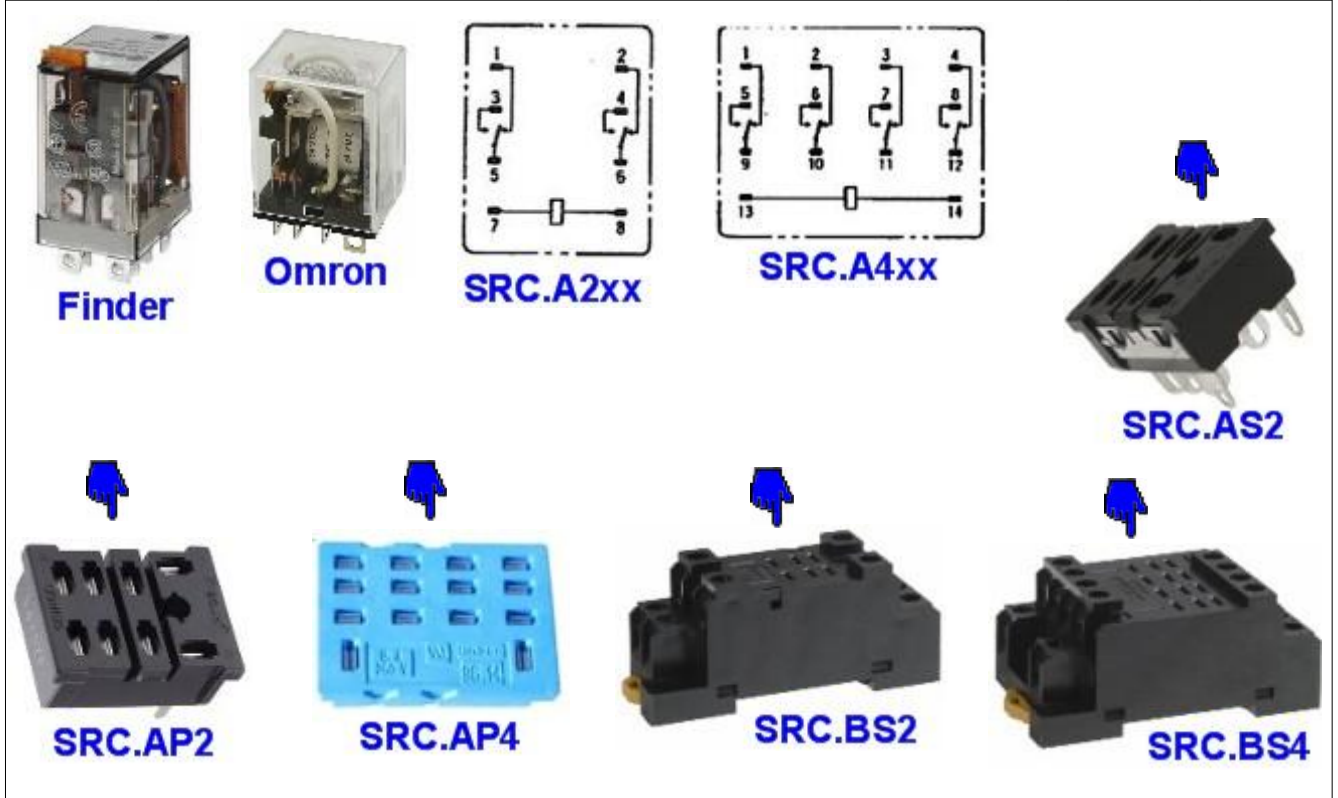

Power Relay 4PDT 220VAC/10A DC-Version

Order No	Min Voltage VDC	Rated Voltage VDC	Max Voltage VDC	Drop Out VDC	Coil Current mA	Resistance Ω	Finder Series	Omron Series
SRC.A4U6	4.8	6	6.6	0.6	240	25	56.34	LY4
SRC.A4U12	9.6	12	13.2	1.2	120	100		
SRC.A4U24	19.2	24	26.4	2.4	69	350		
SRC.AP4	For PCB mounting						96.14SMA	P14-0
SRC.BS4	Relay socket with screw terminals for DIN rail or screw mounting						96.74	PTF14A-E

Power Relay DPDT 230VAC/10A AC-Version

Order No	Min Voltage	Rated Voltage	Max Voltage	Drop Out	Coil Current	Resistance	Finder Series	Omron Series
	VAC	VAC	VAC	VAC	mA	Ω		
SRC.B2U6	4.8	6	6.6	1.8	214.1	28	56.34	LY4
SRC.B2U12	9.6	12	13.2	3.6	106.5	112.7		
SRC.B2U24	19.2	24	26.4	7.2	53.8	446		
SRC.B2U220	184	230	253	69	4.6	5000		
SRC.AP2	For PCB mounting						96.12	PT08-02
SRC.AS2	Socket with soldering lugs							PT08
SRC.BS2	Relay socket with screw terminals for DIN rail or screw mounting						96.72SMA	PTF08A-E



Finder



Omron

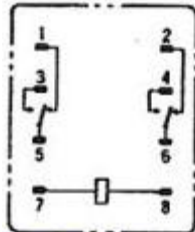

SRC.A2xx

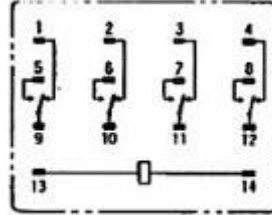

SRC.A4xx



SRC.AS2



SRC.AP2



SRC.AP4



SRC.BS2



SRC.BS4

Power Relays 4PDT 230VAC/10A AC-Version

Order No	Min Voltage	Rated Voltage	Max Voltage	Drop Out	Coil Current	Resistance	Finder Series	Omron Series
	VAC	VAC	VAC	VAC	mA	Ω		
SRC.B4U6	4.8	6	6.6	1.8	386	15.5	56.34	LY4
SRC.B4U12	9.6	12	13.2	3.6	199	60.3		
SRC.B4U220	184	230	253	69	13.1	17557		
SRC.B3U230	184	230	253				62.83.8	
SRC.AP4	For PCB mounting						96.14SMA	P14-0
SRC.BS4	Relay socket with screw terminals for DIN rail or screw mounting						96.74	PTF14A-E

General Purpose Relays DPDT 250VAC/10A – DC Version

Order No	Min Voltage	Rated Voltage	Max Voltage	Drop Out	Coil Current	Resistance	Finder Series
	VDC	VDC	VDC	VDC	mA	Ω	
SRA.2U6	4.8	6	6.6	0.9	200	30	60.12
SRA.2U12	9.6	12	13.2	1.8	100	120	
SRA.2U24	19.2	24	26.4	3.6	50	480	
SRA.2U48	38.4	48	52.8	7.2	25	1920	



SMR.A8

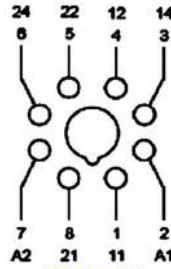

SMR.A8



SMR.A11

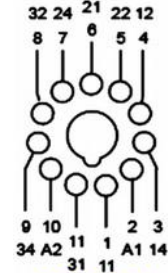

SMR.A11



SMR.B8K



SMR.B8P



SMR.E8



SMR.B11K

General Purpose Relays 3PDT 250VAC/10A – DC-Version

Order No	Min Voltage	Rated Voltage	Max Voltage	Drop Out	Coil Current	Resistance	Finder Series
	VDC	VDC	VDC	VDC	mA	Ω	
SRA.3U6	4.8	6	6.6	0.9	200	30	60.13
SRA.3U12	9.6	12	13.2	1.8	100	120	
SRA.3U24	19.2	24	26.4	3.6	50	480	
SRA.3U48	38.4	48	52.8	7.2	25	1920	

Suitable sockets for both series

Order No	Number Poles	Connection					
SMR.B8P	8	PCB				Schurter	37.3121
SMR.B11P	11		Lumberg				11 PGR 19
SMR.B8K	8	Soldering lugs				Finder	90.12
SMR.B11K	11		Schurter				37.4601
SMR.A8	8	Screw terminals for DIN rail or screw mounting				Finder	90.82.30
SMR.A11	11	Screw terminals for DIN rail or screw mounting				Finder	90.83.3
SMR.E8	8	Built-in connector for PCB mounting				Schurter	40.3201

General Purpose Relays DPDT 250VAC/10A – AC-Version

Order No	Min Voltage	Rated Voltage	Max Voltage	Drop Out	Coil Current	Resistance		Finder Series
	VAC	VAC	VAC	VAC	mA	Ω		
SRB.2U6	4.8	6	6.6	0.9	400	15	50Hz	60.12
SRB.2U12	9.6	12	13.2	1.8	100	60	50Hz	
SRB.2U24	19.2	24	26.4	3.6	100	240	50Hz	
SRB.2U110		110					50Hz	
SRB.2U220	176	220	242	33	11	20000	50Hz	

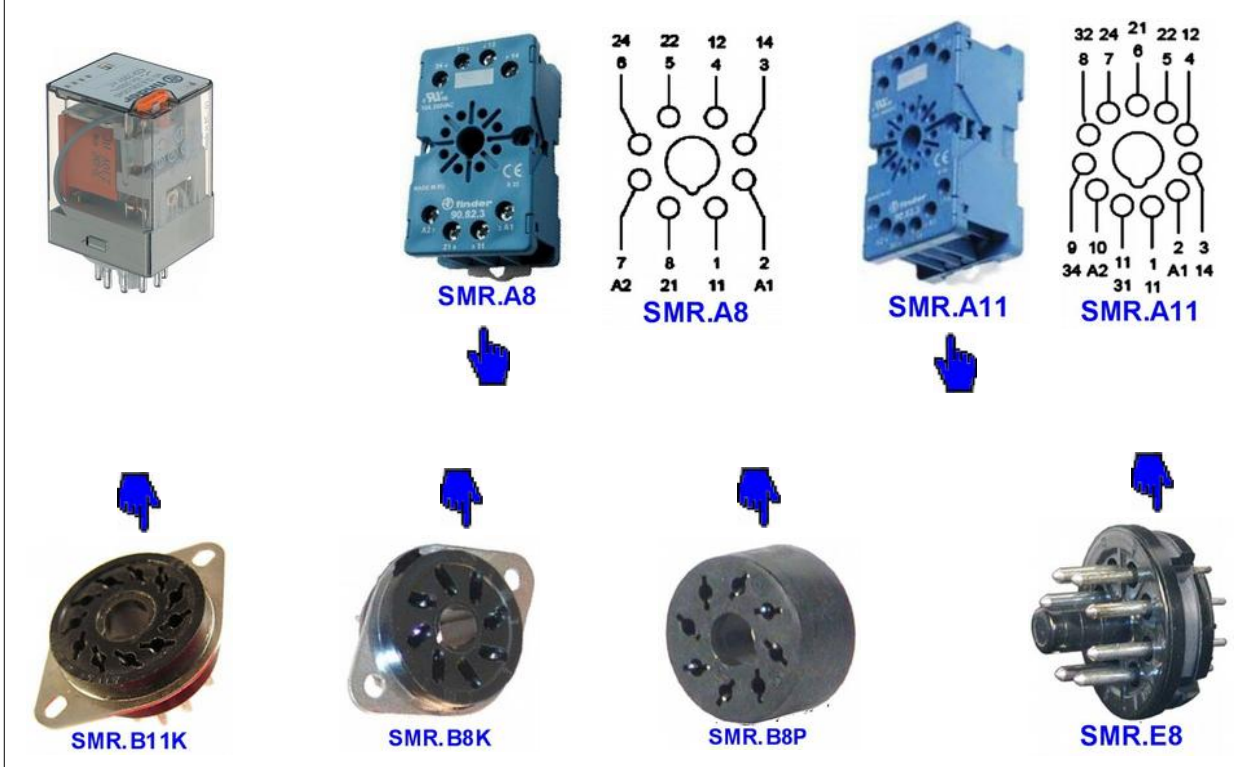

General Purpose Relays 3PDT 250VAC/10A – AC-Version

Order No	Min Voltage	Rated Voltage	Max Voltage	Drop Out	Coil Current	Resistance		Finder Series
	VAC	VAC	VAC	VAC	mA	Ω		
SRB.3U6	4.8	6	6.6	0.9	400	15	50Hz	60.13
SRB.3U12	9.6	12	13.2	1.8	100	60	50Hz	
SRB.3U24	19.2	24	26.4	3.6	100	240	50Hz	
SRB.3U110		110					50Hz	
SRB.3U220	176	220	242	33	11	20000	50Hz	

Suitable Sockets for Both Series

Order No	Number Poles	Connection					
SMR.B8P	8	PCB mounting				Schurter	37.3121
SMR.B11P	11		Lumberg				11 PGR 19
SMR.B8K	8	Soldering Lugs				Finder	90.12
SMR.B11K	11		Schurter				37.4601
SMR.A8	8	Screw terminals for DIN rail or screw mounting				Finder	90.82.30
SMR.A11	11	Screw terminals for DIN rail or screw mounting				Finder	90.83.3
SMR.E8	8	Built-in connector for PCB mounting				Schurter	40.3201

Micro Contactor Relays 230VAC/440VAC (3 or 4 Poles)

Order No	Number Poles	Rated Voltage VAC	Rated Current AC1 440V A	NO	NC	Connection	Benedict	
SRE.3E.1A230AC	3	230	12	1	1	Solder	K0-05D01	
SRE.3E.1A24AC		24					K0-05D01	
SRE.3E.1E230AC		230					Screw	K0-05D10
SRE.3E.1E24AC		24						K0-05D10
SRE.P3E.1A230AC		230	9	1	1	Solder	K0-05L01	
SRE.P3E.1A24AC		24					K0-05L01	
SRE.P3E.1E230AC		230					K0-05L10	
SRE.P3E.1E24AC		24						
SRE.4E230AC	4	230	12			Screw	K0-05D00-40	
SRE.4E24AC		24					K0-05D00-40	
SRE.P4E230AC		230	9			Solder	K0-05L00-40	
SRE.P4E24AC		24					K0-05L00-40	

With DC Operation

Order No	Number Poles	Rated Voltage VDC	Rated Current AC1 690V A	NO	NC	Connection	Benedict
SRE.P4E24DC		24	16			Solder	K1-09L00-40

